

## Contents

---

<b>1 Warranty</b> .....	<b>4</b>
<b>2 Intended use</b> .....	<b>4</b>
<b>3 How to handle stainless steel and other materials</b> .....	<b>5</b>
<b>4 Information for returning pumps</b> .....	<b>5</b>
<b>5 Environment and disposal of waste</b> .....	<b>5</b>
<b>6 When you unpack your pump</b> .....	<b>6</b>
<b>7 Sinusoidal pumps - an overview</b> .....	<b>6</b>
<b>8 Safety notes</b> .....	<b>6</b>
8.1 Obligation of the operating organisation .....	7
8.2 Organisational measures .....	7
8.3 Obligation of the operators .....	7
8.4 Personnel training .....	7
8.5 Safety measures .....	7
8.6 Dangers when handling the machine .....	7
8.7 Safety measures in normal operation .....	7
8.8 Protective devices .....	7
8.9 Dangers due to hazardous pumped material .....	7
8.10 Dangers due to electrical energy .....	7
8.11 Dangers due to hydraulic energy .....	8
8.12 Special danger points .....	8
8.13 Constructional changes to the machine .....	8
8.14 Noise .....	8
8.15 Limit values for the pump .....	9
8.16 Maintenance and repair .....	9
8.17 Cleaning the pump .....	10
8.18 Faults .....	10
<b>9 Pump specifications</b> .....	<b>10</b>
9.1 Standards .....	10
9.2 Dimensions .....	11
Dimensions in millimetres: .....	11
Dimensions in inches: .....	11
9.3 Unit weights .....	12
<b>10 Transport</b> .....	<b>13</b>
<b>11 Good pump installation practice</b> .....	<b>14</b>
11.1 Dos and don'ts .....	14
11.2 Connection to the piping .....	14
11.3 Cavitation .....	16
11.4 Possible pump orientations .....	17
11.5 Connecting to a power supply .....	17
<b>12 Start-up and operation</b> .....	<b>18</b>
<b>13 Flushing the seal system</b> .....	<b>19</b>
13.1 Dynamic flushing .....	19
13.2 Static flushing device .....	19
13.3 Fitting a flush ring .....	20

---

<b>14 Cleaning and sterilisation</b> .....	<b>21</b>
<b>15 Changing the oil</b> .....	<b>23</b>
<b>16 Heating and cooling option</b> .....	<b>23</b>
<b>17 Troubleshooting</b> .....	<b>24</b>
17.1 Technical support .....	24
<b>18 Disassembly and assembly</b> .....	<b>25</b>
18.1 Disassembling the pump .....	25
18.2 Disassembling the seal system .....	28
18.3 Disassembling the middle housing .....	30
18.4 Disassembling the back housing/Changing the nozzle orientation .....	30
18.5 Accessing the shim ring to center the rotor .....	31
18.6 Checking the X-Dimension .....	31
18.7 Assembling the front seal .....	32
18.8 Assembling the pump head .....	34
18.9 Assembling the flush ring of a single mechanical seal system .....	37
18.10 Assembling the back seal in a double mechanical seal system .....	38
<b>19 Tightening torques</b> .....	<b>41</b>
19.1 Shaft—Locking screw wrench sizes .....	43
<b>20 Parts lists</b> .....	<b>44</b>
20.1 Pumps .....	45
20.2 Sealing System (Pos. X) .....	53
20.3 Atmospheric Seal (Pos. Y) .....	55
20.4 Double Mechanical Seal (Pos. Y) .....	56
20.5 Static flush system .....	58
20.6 Dynamic flush system .....	60
20.7 Tools .....	61
<b>21 Trademarks</b> .....	<b>62</b>
<b>22 Disclaimers</b> .....	<b>62</b>
<b>23 Publication history</b> .....	<b>62</b>



Regulations of the EC/EU directive 2006/42/EC Annex II 1.A

<b>2006/42/EG</b>	Directive 2006/42/EC of the European Parliament and of the Council of 17 May 2006 on machinery and amending Directive 95/16/EC (recast) (1 ) Official Journal of the EU: L 157/24 of 09.06.2006
<b>2014/30/EU</b>	Directive 2014/30/EU of the European Parliament and of the Council of 26 February 2014 on the harmonisation of the laws of the Member States relating to electromagnetic compatibility (recast), Official Journal of the EU: L 96/79 of 29.03.2014
<b>2014/35/EU:2014-02-26</b>	Directive 2014/35/EU of the European Parliament and of the Council of 26 February 2014 on the harmonisation of the laws of the Member States relating to the making available on the market of electrical equipment designed for use within certain voltage limits
<b>2014/68/EU, Artikel 4.3</b>	Directive 2014/68/EU of the European Parliament and of the Council of 15 May 2014 on the harmonisation of the laws of the Member States relating to the making available on the market of pressure equipment

Harmonised standards:

<b>EN ISO 12100: 2011-03</b>	Safety of machinery - General principles for design - Risk assessment and risk reduction
<b>EN ISO 13857: 2008</b>	Safety distances against reaching of hazardous areas
<b>EN 809: 1998+A1:2009 + AC:2010</b>	Pumps and pump units for liquids - General safety requirements



Machinery Safety Regulations 2008 No. 1597 as per Annex II 1.A

<b>2008 No. 1597</b>	The Supply of Machinery (Safety) Regulations 2008, made 19th June 2008, laid before Parliament 23rd June 2008, coming into force 29th December 2009
<b>2016 No.1091</b>	The Electromagnetic Compatibility Regulations 2016, made 15th November 2016, laid before Parliament 16th November 2016, Coming into force 8th December 2016
<b>2016 No. 1101 Annex I No. 1.5.1 of 2008 No 1597</b>	The Electrical Equipment (Safety) Regulations 2016

Harmonised standards:

<b>BS EN ISO 12100:2010-12-31</b>	Safety of machinery - General principles for design - Risk assessment and risk reduction
<b>BS EN ISO 13857: 2008</b>	Safety distances against reaching of hazardous areas
<b>BS EN 809+A1:1998-12-15</b>	Pumps and pump units for liquids - General safety requirements

# 1 Warranty

Watson-Marlow GmbH MasoSine Division ("MasoSine") warrants this product to be free from defects in materials and workmanship for a period of two (2) years from the date of shipment. This warranty extends only to the original buyer. Products manufactured by others but furnished by seller are exempted from this warranty and are limited to original manufacturer's warranty.

This warranty shall not affect the warranty of the gear, motor or any other component which is not manufactured by MasoSine.

MasoSine will not be liable for any loss, damage, or expense directly or indirectly related to or arising out of the use of its products, including damage or injury caused to other products, machinery, buildings, or property. MasoSine will not be liable for consequential damages, including, without limitation, lost profits, loss of time, inconvenience, loss of product pumped, and loss of production. This warranty does not obligate MasoSine to bear any costs of removal, installation, transportation, or other charges which may arise in connection with a warranty claim.

Specific exceptions to the above warranty are:

## 1.0.1 Exceptions

Warranty and liability claims for personal and material damage are excluded if they are attributable to one or several of the following causes:

- Normal wear and tear of the product
- Accident, misuse, or improper installation, operation, or maintenance of the product
- Deterioration of the products, in whole or in part, which is incidental to the transit of the product
- Use of the machine not as intended
- Operating the machine with defective safety devices or safety and protective devices not correctly attached or not functioning
- Non-compliance with the operating instructions regarding transport, storage, installation, start-up, operation, maintenance and setting of the machine.
- Unauthorised constructional changes to the machine
- Alterations or repairs performed by buyer without the written consent of MasoSine
- Catastrophe due to the effect of foreign bodies and acts of God
- Abnormal conditions such as, without limitation, corrosive attack or excessive dirt in the system, or electrical supply failure
- Wilful default or negligence by the buyer, its employees, agents consultants, or subcontractors

MasoSine grants no implicit warranties on the suitability of the products described for a certain application. MasoSine accepts no liability for errors contained in this documentation or consequential damage occurring due to the design, performance and the use of this documentation.

MasoSine's "General sales and delivery conditions" contain full details. These are available to the purchaser at the latest when the purchase contract is finalised.

Subject to the warranty provisions in this section, MasoSine warrants that if the buyer returns the product within the twenty-four month warranty period and on MasoSine's examination such product proves defective as to material or workmanship, MasoSine shall make good the defect without charge by, at MasoSine's option:

- repairing the defective product;
- replacing defective components of the defective product; or
- replacing the defective product in its entirety

## 1.0.2 In no event:

- i. shall the cost of the customer's exclusive remedy exceed the purchase price of the product;
- ii. shall MasoSine be liable for any special, indirect, incidental, consequential, or exemplary damages, however arising, even if MasoSine has been advised of the possibility of such damages.

MasoSine shall not be liable for any loss, damage, or expense directly or indirectly related to or arising out of the use of its products, including damage or injury caused to other products, machinery, buildings, or property. MasoSine shall not be liable for consequential damages, including, without limitation, lost profits, loss of time, inconvenience, loss of product being pumped, and loss of production.

This warranty does not obligate MasoSine to bear any costs of removal, installation, transportation, or other charges which may arise in connection with a warranty claim.

MasoSine shall not be responsible for shipping damage of returned items.

Notwithstanding any other terms of this section, MasoSine does not limit or exclude its liability for fraud or fraudulent misrepresentation or for death or personal injury resulting from its negligence or the negligence of its employees, agents or subcontractors.

# 2 Intended use

The intended use of this product is listed in the order confirmation. The product should not be put to a different use or a use going beyond the use described.

Consult MasoSine if you wish to change the product, its pressure, speed or operating temperature.

## 3 How to handle stainless steel and other materials

### 3.0.1 Stainless steel corrosion

Corrosion such as rust might be caused by chemical attack. Use only cleaning liquids which are suitable for use with stainless steel. Take care when deciding on the concentration, temperature and exposure time of the chemicals, to avoid chemical attack.

### 3.0.2 Non-galling material

This non-galling alloy is a nickel based, corrosion resistant material which was developed for use in positive displacement pumps. It is listed in the 3-A Standards and is thereby accepted for use with product exposed surfaces. Do not use in combination with highly concentrated nitric acid, for example, during passivation of new stainless steel piping systems. In this case remove the rotor and the gate during the passivation process to avoid damage or chemical attack. When removing the rotor, a double mechanical seal or a quench with a lip seal is needed, and you should close the connections for the flushing fluid with plugs to keep the liquid in the pump during the passivation process. Do not use a concentration of more than 3% of nitric acid for the CIP cleaning fluid.

### 3.0.3 Running marks

Due to test runs before delivery of the pump from the factory, pressure peaks, operation under pressure or temperature shocks, running marks may appear on the stainless-steel parts. These superficial marks do not influence the function of the pump.

### 3.0.4 Handling of elastomers and plastic parts after the passivation process

Check elastomeric and plastic parts after passivation for chemical attack and replace them if necessary.

## 4 Information for returning pumps

In compliance with the regulations in your area concerning the control of substances hazardous to health, you are required to declare the substances which have been in contact with product(s) you return to MasoSine or its distributors. Failure to do so will cause delays. Please ensure that you email us this information and receive a RGA (Returned Goods Authorisation) before you despatch the product(s). A copy of the RGA form must be attached to the outside of the packaging containing the product(s).

Please complete a separate decontamination certificate for each product and attach it to the outside of the packaging containing the product(s). A copy of the appropriate decontamination certificate can be downloaded from the Watson-Marlow Limited website at [www.wmftg.com](http://www.wmftg.com).

You are responsible for cleaning and decontaminating the product(s) before return.

## 5 Environment and disposal of waste



**Always observe the local rules and regulations with respect to safe disposal of waste.**

Enquire within your local government about the possibilities for reuse or environment-friendly processing of materials, (contaminated) lubricant and oil. Dispose of materials safely, and in accordance with regulations in your area.

- Stainless steel parts should be recycled where possible
- Plastic should be recycled where possible
- Oil, grease and lubricants should be washed out and disposed of properly according to local regulations
- Elastomers should be recycled where possible

## 6 When you unpack your pump

Unpack all parts carefully, retaining the packaging until you are sure all components are present and in good order. Check against the components supplied list, below.

### 6.0.1 Packaging disposal

Dispose of packaging materials safely, and in accordance with regulations in your area. The outer carton is made of corrugated cardboard and can be recycled.

### 6.0.2 Inspection

Check that all components are present. Inspect components for damage in transit. If anything is missing or damaged, contact your distributor immediately.

### 6.0.3 Components supplied

- MasoSineCerta Compact Compact sinusoidal pump
- The technical datasheet identifying, describing and defining the pump
- Operating instructions
- Blocking tool and socket adapter



### 6.0.4 Optional items

- Motor
- Left and right baseplate

### 6.0.5 Optional special design

- Flush systems
- Guard master
- Jacketing for heating and cooling

### 6.0.6 Storage

This product has an extended shelf life. However, plastic parts and elastomeric parts should be stored in a cool, dry environment. Care should be taken after storage to ensure that all parts function correctly.

## 7 Sinusoidal pumps - an overview

The functioning principle of MasoSine pumps is ingeniously simple.

The pump consists of modular components.

The **sinusoidal rotor** creates a **chamber** within the **pump body** four times per revolution, in which the pumped fluid is displaced. As a filled chamber rotates, it contracts, closes and discharges its contents. At the same time, the opposite chamber opens by the same fraction of a millimetre to draw in more fluid. The result is a pump free of pulsation.

The **gate** works as a seal between the pressure side and the suction side of the pump. It prevents an equalisation of the pressure created by the rotor, stopping it escaping to the suction side.

## 8 Safety notes

Knowledge of these safety instructions and of the safety regulations in your area is a requirement for safe handling and trouble-free operation of this machine.

These operating instructions contain the most important instructions to operate the machine safely. These operating instructions, especially the safety instructions, must be observed by all persons who work on the machine. In addition, the rules and regulations for accident prevention applicable at the place of use must be obeyed.

The following safety instructions must be observed absolutely. They are an essential and indispensable part of the user documentation. Non-compliance can result in failure of warranty claims.

It is recommended in the interests of all involved to enter all installation measures, maintenance, fault and repair cases, training courses, instructions and special occurrences in a logbook assigned to the machine.



This symbol highlights a safety instruction which must be followed to avoid danger to people or to the pump.



This symbol means: Beware of high voltage.



This symbol means: Caution, hot surface.



**Caution: The pump contains rotating parts. The user must take care not to trap fingers, loose clothing, etc. inside the pump.**

## 8.1 Obligation of the operating organisation

The operating organisation must ensure that people who work on the machine are familiar with and comply with the regulations concerning working safety and accident prevention.

## 8.2 Organisational measures

The personal protective equipment required must be provided by the operating organisation. Safety devices must be checked regularly.

## 8.3 Obligation of the operators

People who work on the machine must observe the relevant safety regulations concerning working safety and accident prevention before starting work; must read the safety chapter and the warning notes in these operating instructions.

## 8.4 Personnel training

Only trained people may work on the machine. Their responsibilities must be defined clearly for assembly, start-up, operation, setting, maintenance and repairing.

## 8.5 Safety measures

The operating instructions must be kept with the machine. General and local regulations for accident prevention and environmental protection, and the operating instructions, must be observed. Safety and danger warnings on the machine must be legible.

## 8.6 Dangers when handling the machine

The MasoSine pump is built according to state-of-the-art principles and the recognised safety engineering rules. Nevertheless, danger to life and limb of the user or third persons, or impairments to the machine or to other assets, can arise in its use.

The machine must be used only:

- for its intended use
- if it is in a safe engineering condition.

Faults which may compromise safety must be rectified immediately.

## 8.7 Safety measures in normal operation

Operate the machine only if all protective devices are functioning. Before switching the machine on make sure that no one can be endangered when the machine starts. At least once per shift inspect the machine for damage and for proper functioning of the safety devices.

## 8.8 Protective devices

All protective devices must be attached correctly and functioning before every start-up. Protective devices may be removed only after the machine has stopped and protection measures against restarting the machine have been taken.

After spare parts have been fitted, protective devices must be attached according to the operating organisation's regulations.

If contact with hot or cold machine parts could be dangerous, protection must be provided for the pump user.

## 8.9 Dangers due to hazardous pumped material

If hazardous material is to be pumped, the appropriate regulations must be observed.

## 8.10 Dangers due to electrical energy

Work on the electrical supply must be performed only by an electrician.



**Check the electrical equipment of the machine regularly. Rectify loose connections and scorched cables immediately.**

Keep the control cabinet locked closed or secured with a tool. Access is allowed only to authorised personnel.

If work on parts conducting voltage must be done, call in a second person to switch off the mains power if necessary.

Electrical connection of the pump must be made according to local regulations, by skilled personnel only.

### 8.11 Dangers due to hydraulic energy

Only personnel with special knowledge and experience in hydraulics may work on hydraulic devices.  
Relieve the pressure in the system sections and pressure lines to be opened before starting repair work.  
Replace hydraulic hose lines at appropriate intervals, even if no safety-relevant defects are detectable.

### 8.12 Special danger points



The pump contains a rotating rotor, which can crush or sever fingers and hands. The pump must be guarded so that it is not possible for people to hold the pump by its inlet or delivery ports with the rotor running. When the rotor is stationary, the drive must be secured against unintentional start-up. Increased danger exists if pipes are dismantled or the pump is open.

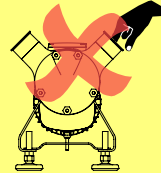

### 8.13 Constructional changes to the machine

Make no changes, attachments or conversions to the machine without the manufacturer's approval. All conversion measures require the written confirmation of Watson-Marlow GmbH MasoSine Division.

Replace machine parts which are not in perfect condition immediately. Use only original spare and wearing parts. Parts that are not obtained from MasoSine are not guaranteed to be designed and manufactured in compliance with load and safety requirements.

The warranty is invalid if genuine spare parts from MasoSine are not used.

### 8.14 Noise

The continuous sound pressure level proceeding from the machine should not exceed 70 dB(A). Higher sound pressure levels that can cause deafness can arise, depending upon local conditions. If this occurs, protect the operating personnel with appropriate protective equipment / protective measures.



## 8.15 Limit values for the pump

The pump's maximum speed, maximum pressure and maximum temperature are included in the technical data sheet supplied with each pump. These limit values must not be exceeded in any circumstances. This applies in particular when using a frequency converter.

If pump is supplied without a drive, the following values apply:

	<b>C100 Compact</b>	<b>C200 Compact</b>	<b>C250 Compact</b>	<b>C300 Compact</b>	<b>C400 Compact</b>	<b>C500 Compact</b>	<b>C600 Compact</b>
Maximum pressure*	6 bar / 87 psi	6 bar / 87 psi	6 bar / 87 psi	6 bar / 87 psi	6 bar / 87 psi	6 bar / 87 psi	6 bar / 87 psi
Maximum speed*	1000rpm	1000rpm	800rpm	600rpm	600rpm	600rpm	600rpm
Maximum temperature*	100C/ 212F	100C/ 212F	100C/ 212F	100C/ 212F	100C/ 212F	100C/ 212F	100C/ 212F
Minimum temperature*	-20C/-4F	-20C/-4F	-20C/-4F	-20C/-4F	-20C/-4F	-20C/-4F	-20C/-4F

\* These limits may vary, depending on the drive, the application and the rating of the pump. (See your purchase order confirmation, or contact MasoSine and quote your pump's serial number.) On customer request, higher pressures and temperatures are possible.

## 8.16 Maintenance and repair

Maintenance and repair work on the pump should only be carried out by trained service personnel, who should have read and understood this manual prior to installing, operating or servicing this equipment.

Inform operating personnel before starting maintenance and repair work. Protect all plant parts and operating media connected before and after the machine, such as compressed air and hydraulics, against unintentional start-up. In all maintenance, inspection and repair work, switch the machine off and secure the main switch against unintentional start-up.

Secure larger assemblies carefully to lifting gear. Check loosened screw connections for firm seating. Use only original spare parts.



**After maintenance work is finished, check the safety devices are functioning.**

### 8.16.1 Bearings maintenance

<b>Certa Compact pump model</b>	<b>Bearings maintenance interval</b>
C100 Compact	10,000 hrs
C200 Compact	10,000 hrs
C250 Compact	10,000 hrs
C300 Compact	10,000 hrs
C400 Compact	10,000 hrs
C500 Compact	10,000 hrs
C600 Compact	8,000 hrs

## 8.16.2 Maintenance intervals and actions

Interval	Sub-assembly (if present)	Skill level	Action
Weekly	Mechanical seal	Operator Expert	Check for leaks In case of leakage: - Determine the degree of leakage - Consult Watson-Marlow MasoSine - Replace the wearing parts
	Elastomeric seals (e.g. pump housing)	Operator Expert	Check for leaks In case of leakage: - Determine the degree of leakage - Consult Watson-Marlow MasoSine - Replace the O-rings
	Heating	Expert	Check the electrical connection Check the function
	Motor	Expert	Check for wear Check for leakage Check for strange sounds
Every 6 months or 500 cleaning cycles	Mechanical seal and Elastomers	Expert	Check for leakage Check for chemical attack Check for wear Check elastomer parts for elasticity and changes in characteristics Replace if necessary

Points to observe during maintenance:

- Clean all accessible seal grooves before assembling
- All accessible surfaces, threads and dismantled components shall be cleaned with a suitable cleaning agent
- Clean the thread in the shaft and on the locking nut before installing the lock nut again, to prevent the build-up of microorganisms in the area of the thread (for example, use a small brush and / or compressed air or pressurised water / cleaning fluid for the blind hole)
- Check elastomer parts for elasticity and changes in characteristics (e.g. stickiness, roughness, discolouring, substantial deformation)
- To assemble elastomer parts in food and beverage applications, use only NSF H1 listed lubricants that are compatible with the elastomer material. Use as little lubricant as possible.

## 8.17 Cleaning the pump

Handle substances and materials used correctly, especially when working on lubricating systems and when cleaning with solvents. For information on cleaning the parts in contact with the pumped fluid, see "Cleaning and sterilisation" on page 21.

## 8.18 Faults

If an operating fault occurs, switch off the machine and secure it against unintentional start-up.

# 9 Pump specifications

Your pump carries a name plate. It includes a serial number, which identifies the features of the product. The serial number also appears on the technical datasheet.

An example name plate is shown below.

(the abbreviations on the label are as follows: Pm=maximum pressure, max.=maximum speed, s/n=serial number)

## 9.1 Standards

Standards applicable to the pump connected to a drive:

See "Regulations of the EC/EU directive 2006/42/EC Annex II 1.A" on page 3 or supplied with the pump.

## 9.2 Dimensions

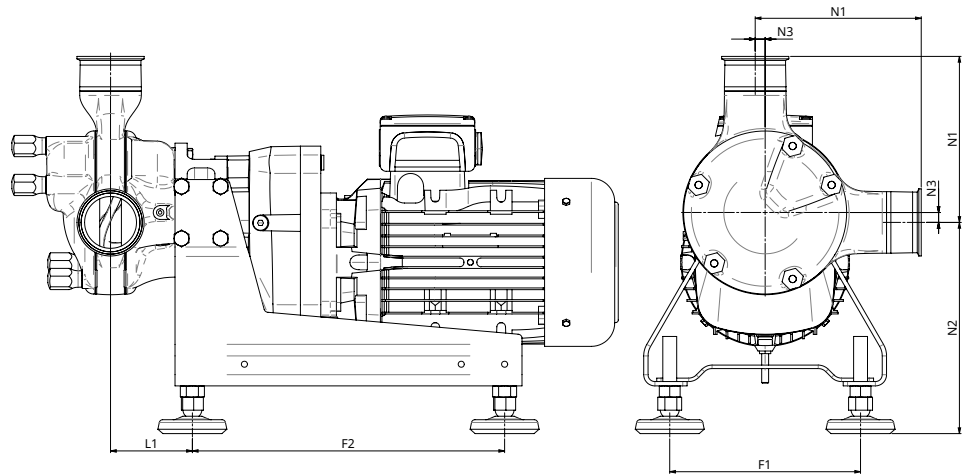

Dimensions in millimetres:

Model	Nozzles			Foot		Length
	N1	N2	N3	F1	F2	L1
	mm	mm	mm	mm	mm	mm
C100 Compact	139	195-245	10	160	280	67.5
C200 Compact	155	205-255	10	180	330	69
C250 Compact	192	245-295	12	220	360	74.5
C300 Compact	238	245-295	18	240	440	89
C400 Compact	324	305-355	31	300	560	109
C500 Compact	327	310-360	25	300	560	137
C600 Compact	343	330-380	28	300	610	177.5

Dimensions in inches:

Model	Nozzles			Foot		Length
	N1	N2	N3	F1	F2	L1
	inch	inch	inch	inch	inch	inch
C100 Compact	5.47	7.68-9.65	0.39	6.3	11.02	2.66
C200 Compact	6.1	8.07-10.04	0.39	7.09	12.99	2.72
C250 Compact	7.56	9.65-11.61	0.47	8.66	14.17	2.93
C300 Compact	9.37	9.65-11.61	0.71	9.45	17.32	3.5
C400 Compact	12.76	12.01-13.98	1.22	11.81	22.05	4.29
C500 Compact	12.87	12.2-14.17	0.98	11.81	22.05	5.39
C600 Compact	13.5	12.99-14.96	1.1	11.81	24.02	6.99

### 9.3 Unit weights

Pump model	Pump only		Standard baseplate		
	kg	pounds	number	kg	pounds
C100 Compact	10	22.05	K-...-C100CC	5.5	12.13
C200 Compact	13	28.66	K-...-C200CC	6	13.23
C250 Compact	20	44.09	K-...-C250CC	8	17.64
C300 Compact	30	66.14	K-...-C300CC	9.5	20.94
C400 Compact	60	132.28	K-...-C400CC	17.5	38.58
C500 Compact	100	220.46	K-...-C500CC	17.5	38.58
C600 Compact	130	286.60	K-...-C600CC	23	50.71

## 10 Transport

Choose the right means of transport according to the size of the pump and the drive. The pump must be suspended correctly for transport. If using a crane or fork-lift truck, the ropes or belts must be sufficiently dimensioned. If the pump is transported with a lift truck or fork-lift truck, note that the unit's centre point is not necessarily the centre of gravity.

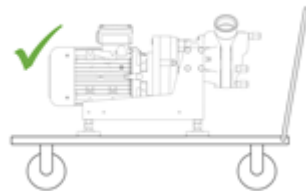
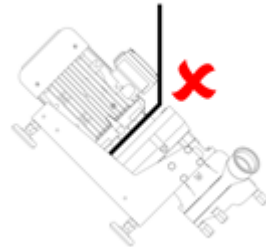

## 11 Good pump installation practice



- Place the pump on a level surface
- The mounting surface should be strong enough to support the pump.
- There should be sufficient space for maintenance work around the pump.
- The motor must receive an adequate air supply.
- The unit must be protected against static charge.
- Ensure the front housing is accessible for easy maintenance.

### 11.1 Dos and don'ts

- Do not build a pump into a tight location without adequate airflow around the pump.
- Do not pump any chemical not compatible with the materials of the pumphead.
- Do keep delivery and suction pipes as short and direct as possible - though ideally not shorter than one metre - and follow the straightest route. Use bends of large radius: at least four times the pipe diameter. Ensure that connecting pipework and fittings are suitably rated to handle the predicted pipeline pressure. Avoid pipe reducers and lengths of smaller bore pipe than the pumphead section, particularly in pipelines on the suction side. Any valves in the pipeline must not restrict the flow. Any valves in the flow line must be open when the pump is running.
- Do use suction and delivery pipes equal to or larger than the nozzle diameter bore.
- Do site the pump at or just below the level of the fluid to be pumped if possible. This will ensure flooded suction and maximum pumping efficiency.
- Valves in the process flow must be opened before the pump operates. Users are advised to fit a pressure relief device between the pump and any valve on the discharge side of the pump to protect against damage caused by accidental operation with the discharge valve closed.

### 11.2 Connection to the piping



**Before connection, clean the piping and remove foreign bodies such as welding residues.**

**Avoid forces and torques acting from the piping on the pump connections (e.g. distortion, expansion due to temperatures etc.) by using compensators or other suitable equipment.**

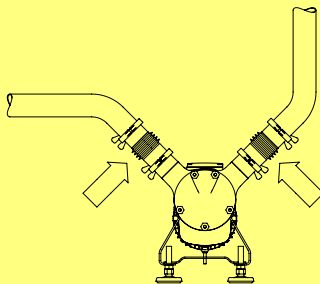

The user must ensure that a pressure rise above the pressure agreed in the purchase order and listed in the technical data sheet is not possible.

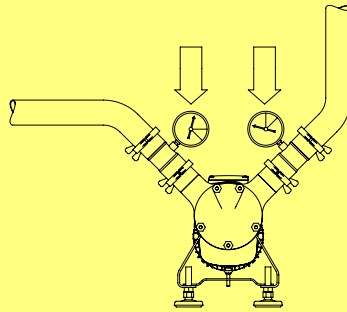

MasoSine pumps normally run with such a low resonant frequency that no damage results. However, particularly when running with inverters, certain frequencies can cause interference vibrations which must be avoided. It is important during commissioning to ascertain whether such vibrations exist and to define them, so that the inverter can be programmed to avoid these frequencies. Similarly, interference from cavitation or rigid lines must be avoided.

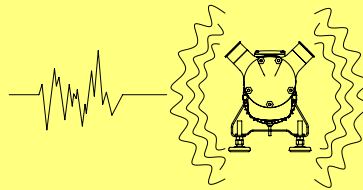

## 11.3 Cavitation

Cavitation is a problem in certain devices where fluid interacts with a moving surface. It can occasionally occur in sinusoidal pumps.

Where a surface moves through a fluid, low pressure areas are formed on the surface. The faster the surface moves, the lower the pressure around it can become. If the static pressure of the liquid falls below its vapour pressure, vapour bubbles form on the pressure side. These implode, causing very high, short-term pressure peaks up to several thousand bar. These pressure peaks can cause material erosion and are noisy.

### 11.3.1 To identify cavitation

If the pump is very noisy and vibrates vigorously, along with the pipe system attached to the pump, cavitation is likely to be the cause.

### 11.3.2 To avoid or remove cavitation

Increasing the inlet pressure on the suction side, installing a larger diameter or shorter inlet pipe or slowing the pump may solve the problem. Make sure that the pump is not starved of duty fluid at all times.

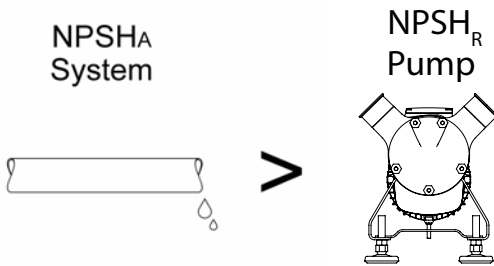

- To prevent cavitation, always ensure that  $NPSHA > NPSHR$ .



**Cavitation can destroy the pump. The operator must ensure that the pump can work free of cavitation.**



## 11.4 Possible pump orientations

The pump can be positioned in one of eight orientations, and can rotate clockwise or counter-clockwise.

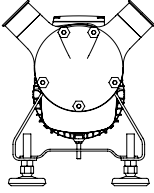
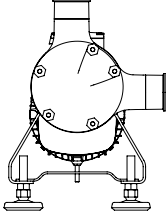
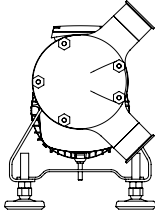
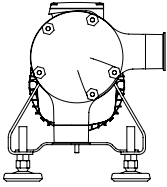
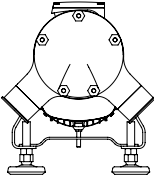
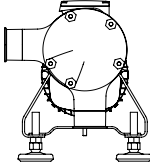
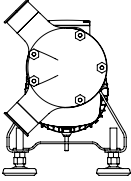
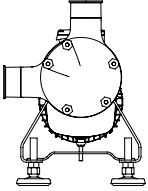
			
10-02	12-03	02-04 *	03-06
			
04-08	06-09	08-10 *	09-12

Unless you specify otherwise when ordering, the pump is delivered in position 10-02.

Special customised nozzle orientations are possible.

\*Please note: According to EHEDG regulations, the pump head should always be completely self-draining. In a standard installation this can only be assured in the 02-04 or 08-10 nozzle position.

### 11.4.1 Changing the pump orientation

See "Disassembling the back housing/Changing the nozzle orientation" on page 30 for details about changing the pump orientation.

## 11.5 Connecting to a power supply



The motor must be connected according to local regulations by a qualified person. See the instruction manual supplied with your drive motor.

## 12 Start-up and operation



- If you are starting the pump for the first time, or have performed cleaning or repair work, check first that all screws are correctly and completely tightened.
- The pump may have been contaminated during transport. Remove the pump front cover and clean if necessary before start-up.



**Observe the appropriate regulations if hazardous fluid is to be pumped.**



**Ensure that the pump is installed in an appropriate position with all necessary safety guards and precautions (sensors, switches, pressure gauges, etc.).**

MasoSine pumps must be primed before use. Before commissioning and during operation, the pump must be filled with fluid, with the fluid level above the rotor (see diagram). This can be done manually through a side channel of your system's pipework, or by using a vacuum device where very viscous fluids are to be pumped; contact MasoSine for further information. The need to prime can be avoided by leaving product in the pump after it is stopped; by leaving CIP or SIP fluid in the pump after cleaning.



**Before start-up, make sure that all valves on the pressure and suction sides are open. The pump must not pump against a closed valve without an over-pressure valve.**



**If the pump leaks, stop pumping as quickly as possible and replace the damaged sealing elements. See "Disassembling the seal system" on page 28.**



**The operator must ensure that the pump can work free of cavitation. Cavitation can destroy the pump. See "Cavitation" on page 16.**

## 13 Flushing the seal system



In order to prevent a dry run and to ensure a proper working sealing system a seal flush is recommended.

Flushing fluid at atmospheric pressure—usually water—flushes the area behind the seal system and prevents the product from hardening and damaging the seal system. If a static flushing device is fitted, the flushing fluid fills the area behind the seal.

- The flushing medium must be at least suitable to the product being pumped. It should not contain abrasive particles, which would damage the seals. We recommend that transparent plastic tubes are used as flushing tubes.
- It can also be used to create a (bacteria tight) barrier to the atmosphere.
- The single mechanical seal should be flushed without pressure: the flushing fluid should be allowed to drain from the system without pressure. The double mechanical seal can be used pressureless or alternatively with an overpressure.
- Fill the pump with liquid to prevent it from running dry, possibly via a separate intake valve connected to the suction or pressure pipe.
- If your pump is set up for permanent flushing, always check the intake and outlet (see diagram below).

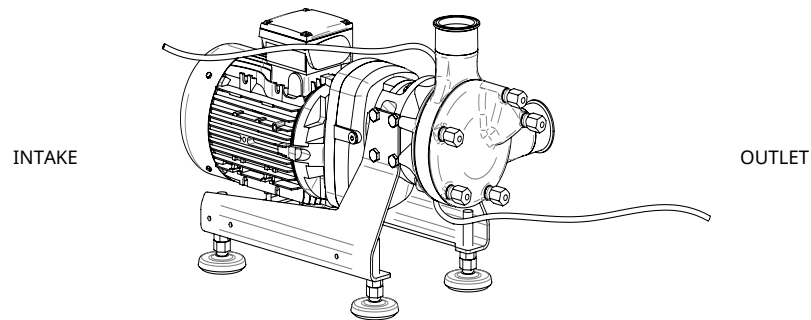

### 13.1 Dynamic flushing

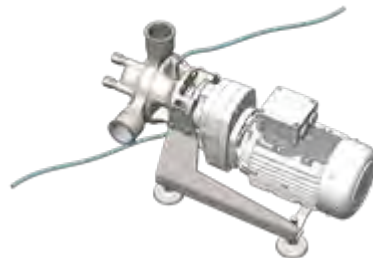

The picture shows a tube connected for the flush system. The tubing should have an outer diameter of 8mm or connection with G1/8 thread.

You should connect the tubes to the highest possible point (outlet) and the lowest possible point (intake), so that there is a 180° angle between them.

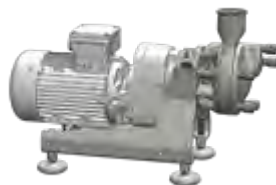

Plug all other possible connections on the pump housing, using the threaded plugs supplied with the pump (see for the part numbers). The other connections are intended for use with different orientations of the pump's nozzles (see "Possible pump orientations" on page 17).

### 13.2 Static flushing device

Before commissioning, fill the flushing device (if supplied) with a suitable flushing fluid, depending on the product being pumped. Fill the sight glass with flushing fluid until the fluid level is just below the bend in the outlet pipe.

### 13.2.1 Fitting the static flushing device

The static flushing device can be fitted to a Certa Compact pump with a flush ring or a double mechanical seal. See also "Assembling the pump head" on page 34.

The connection with the vent pipe must be connected to the highest flush port.

- For a 10/2 nozzle orientation this is the flush port located 45° off the vertical axis.
- For all other nozzle orientations this is the flush port on top of the pump.

The connection with the sight glass must be fitted to the flush port which is offset by 45° from the vertical axis.



Remove the threaded plug of the required flush port by using a 10mm Socket with extension.

Apply an appropriate sealing material (e.g. Teflon tape) to both threads of the double nipples and fit them to the flush ports using a 14mm spanner.

Connect the sight glass and the vent pipe with the installed connectors using two 14mm spanners to tighten them.

Check if the reservoir and the vent pipe are at the same height and close all flush ports.

### 13.2.2 Removing the static flushing device

The static flushing device must be emptied and removed before disassembling the pump. To do this, open the flush port at the lowest point of the pump.

After the flushing device has been emptied, reverse the sequence of operations described above to remove it.

## 13.3 Fitting a flush ring

See "Assembling the flush ring of a single mechanical seal system" on page 37.

## 14 Cleaning and sterilisation



**Attention: Keep a minimum distance of 50cm (20 inches) from the pump while performing high-pressure cleaning.**

MasoSine Certa Compact series pumps are designed to be cleaned in place. Please follow our CIP cleaning instructions below.

Maintaining a clean process line is vital to maintaining a high level of hygiene and no contamination of the end-product. Contamination costs time and money.

The heat or chemical reaction from clean-in-place (CIP) and steam-in-place (SIP) cleaning processes damages a living cell's essential structures, including the cytoplasmic membrane, rendering the cell no longer viable.

The process automatically re-circulates cleaning detergent and rinse solutions.

### 14.0.1 The CIP procedure

- Before the CIP process begins, a preliminary clean should be performed at maximum speed with no back pressure. This will remove most of the residual product.
- Suitable cleaning fluids for the CIP process may include concentrations below 1% of additives. They may be:
  - Sodium hydroxide in distilled water
  - Nitric acid in distilled water
  - Phosphoric acid in distilled water
- CIP cleaning can be carried out between 60C (140F) and 100C (212F), depending on customer needs.
- Cleaning should be done at maximum pump speed to achieve a good cleaning result.
- It is recommended to have a differential pressure on the discharge side of the pump with at least 2.0 bar / 29.0 psi higher than the pressure on the suction side of the pump during the CIP process.
- A velocity of 1.5m/sec (5 ft/sec) is sufficient for most applications.
- A separate CIP supply pump and a bypass might be necessary if the MasoSine pump cannot supply the required CIP solution velocity.

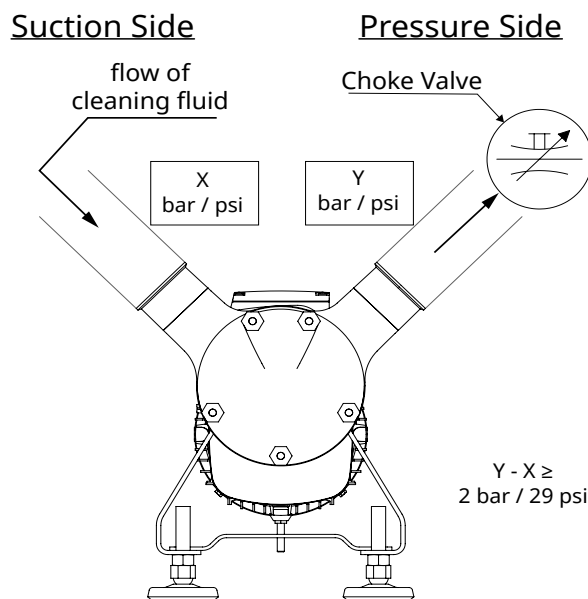

- A choke valve should be installed in the discharge pipeline immediately after the pump. Close the choke valve slowly until the pressure difference is correct.
- The CIP time for the pump is in accordance with the time required for system cleaning: usually 20-40 minutes.

### 14.0.2 Steam-in place (SIP) for MasoSine products

Steam sterilisation kills micro-organisms through the application of moist heat (saturated steam) under pressure, without disassembling the pump.

The heat from steam-in-place (SIP) cleaning processes damages a living cell's essential structures, including the cytoplasmic membrane, rendering the cell no longer viable.

- The pressure should be high enough to ensure that the steam reaches all parts of the pump through the existing clearances.
- The pump needs to be at standstill during SIP sterilisation.



#### Avoid thermal shocks!

Thermal shocks have to be avoided as they might lead to an uneven thermal expansion of the pump components. Uneven expansion caused by a sudden temperature change can lead to marks of the pump components.



After SIP sterilisation, ensure that a suitable acclimatisation period is maintained before the pump is put back into operation

Class II SIP and CIP procedure	Recommended temperature	Recommended pressure differential
CIP	80-90C / 176-194F	2 bar (29 psi)
SIP	120C / 248F	—

### 14.0.3 Key CIP and SIP safety information

- A distance of one metre around the pump should be kept clear during SIP to minimise danger in case of leakage.
- CIP and SIP processes should be monitored continuously.
- If a leak occurs during CIP or SIP, the pumphead should not be touched until system pressure has been relieved and the pumphead has been allowed to cool down.

### 14.0.4 Aseptic processing system

If the equipment is installed in an aseptic processing system that is sterilized by heat and operated at a temperature of 121C (250F) or higher, 3-A Standard 02-11 requires that the system monitors internal pressure and shuts the system down automatically if the product pressure in the system drops below atmospheric pressure. The system shall only be able to be restarted after it has been re-sterilized.

## 15 Changing the oil

Check the Oil regularly according the Drive Suppliers specifications

## 16 Heating and cooling option

Special versions of MasoSine C100 Compact, C200 Compact, C250 Compact, C300 Compact and C400 Compact pumps can be heated or cooled to maintain the required product temperature within the pump—pumping chocolate or ice cream, for example—by passing fluid at the temperature required through crescent-shaped channels in the pump housing and the front housing. The pump has 1/8in connections on two sides though which the heating or cooling agent flows. The position of the connections varies depending on the model. A possible backpressure should not exceed 1bar/15psi. The minimum flow required for the heating/cooling option is 0.2l/min or 0.05gpm.

**Note:** Most pump sizes can be retro-fitted to allow heating and cooling (refer to table below).

**Note:** The heating or cooling temperature must stay within the temperature limits of the pump. These can be found in "Limit values for the pump" on page 9



	<b>C100 Compact</b>	<b>C200 Compact</b>	<b>C250 Compact</b>	<b>C300 Compact</b>	<b>C400 Compact</b>
Pump housing	MP-HZG-G-C100 Compact	MP-HZG-G-C200 Compact	MP-HZG-G-C250 Compact	MP-HZG-G-C300 Compact	MP-HZG-G-C400 Compact
Front cover	MP-HZG-D-C100 Compact	MP-HZG-D-C200 Compact	MP-HZG-D-C250 Compact	MP-HZG-D-C300 Compact	MP-HZG-D-C400 Compact

## 17 Troubleshooting

Fault	Cause	Fix
Pump does not draw in	Direction of rotation not correct	Check direction of rotation
	No wetting liquid in pump	Fill pump with liquid
	Screw fastening not tight	Check screw fastening
	Suction pipe too long	Adapt suction pipe
	Suction pipe too narrow	Adapt suction pipe
	Shaft seal leaking	Check all seals for damage
	Wearing parts worn	Replace wearing parts
	Motor speed not correct	Measure and regulate speed
Pump does not deliver	Direction of rotation not correct	Check direction of rotation
	Suction and pressure pipe interchanged	Check pipe system
	Motor speed not correct	Check pump speed against performance curves - see your purchase order
	Wearing parts worn	Replace wearing parts
Pump is noisy	Inserted gate valve closed	Check pipe system
	Noises from the drive	Consult manufacturer
	Noises from the pump	Consult manufacturer
	Suction pipe too small (cavitation)	Shorten suction pipe or increase diameter, reduce speed
Pump leaks	Knocking noises from the pumphead	Check if gate is worn and replace if necessary Cavitation. Refer to "Cavitation" on page 16
	Sealing system is leaking	Change static/dynamic seal faces
	O-ring seal leaking	Replace O-ring
Pump leaks at front housing or back housing	Seal faces are worn / show burning marks	Use a seal flush to prevent mechanical seal from dry run
	Housing seal not installed or wrongly installed	Install housing O-ring correctly or replace
Pump is blocked	Housing seal defective	Install housing O-ring correctly or replace
	Foreign body in the pump	Remove foreign body, examine pump for damage
Severe wear after short operating time	Power supply interrupted	Check electrical installation and fuses, check drive
	Solids in the pumped fluid	Change the wearing parts frequently; check material compatibility
Rotor has wear on one side	Pumped fluid is abrasive	Choose larger pump, reduce speed
	Rotor not tightened correctly on installation	Tighten shaft nut firmly on block
Pump not clean after CIP cleaning	Adjusting dimensions changed after installing new rotor, new housings, new flange, new drive	Check and correct dimension X: see section "Accessing the shim ring to center the rotor" on page 31
Pump assembly subject to vibrations	Cleaning regulation not complied with.	See section "Cleaning and sterilisation" on page 21
Smells and smoke coming from the pump	Speed of the drive motor is too high	Reduce the speed of the drive motor
	Pump is running dry	Stop the pump immediately. Check inner parts for damage and replace if necessary

### 17.1 Technical support

For full contact details, please go to our website:  
<http://www.watson-marlow.com/gb-en/range/masosine/>



## 18 Disassembly and assembly



Use the appropriate torque value (see "Tightening torques" on page 41)



Before beginning disassembly, disconnect the pump from the mains power, and secure it against unintentional start-up.

### 18.0.1 Removing the static flushing device

If the flushing device has been fitted, it must be emptied and removed before disassembling the pump. For details, see "Static flushing device" on page 19.

## 18.1 Disassembling the pump

### 18.1.1 Removing the front housing



- Make sure the pump is secured to prevent it from tilting.
- Unscrew the cap nuts with a wrench, by turning them counter clockwise.



- Remove the front housing.

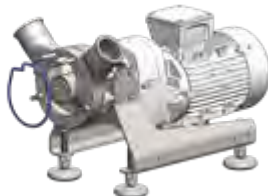

- Carefully remove the seal in the centre of the housing and store it safely.

### 18.1.2 Removing the locking screw

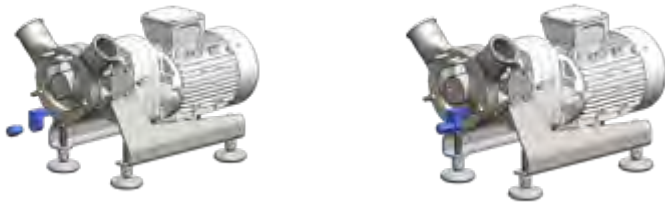

- Use the blocking tool (for part number see section "Sealing System (Pos. X)" on page 53) to lock the rotor and the shaft before opening the locking screw on the rotor.
- Use one of the cap nuts from the front housing to fasten the blocking tool.

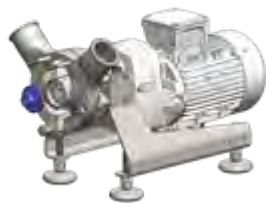

- Open the locking screw using the socket adapter, turning it counter clockwise (for part code see "Sealing System (Pos. X)" on page 53.)



**High torque required!**  
Use appropriate tool

#### Required wrench size for hexagonal locking screw

Pump size	Metric	Inch
C100 Compact/C200 Compact	SW14	9/16"
C250 Compact	SW19	3/4"
C300 Compact/C400 Compact	SW34	1 5/16"
C500 Compact/C600 Compact	SW38	1 1/2"

For required torque See Tightening torques on page 41.



An O-ring seal keeps the disc spring of the locking screw in place.

The component parts of the locking screw.



Locking screw to open with a conventional tool

Locking screw for 3-A and EHEDG to open with the special delivered tool



Hexagonal locking screw with an o-ring



Hexagonal locking screw with gasket

- Remove the blocking tool.

### 18.1.3 Removing the rotor and gate

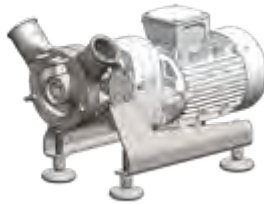

- Pull the rotor, together with the gate, out of the housing, as shown.
- Carefully remove the rotor and store safely. Take care when removing the rotor to ensure the seal faces are not damaged.



**The seal faces are brittle**

To re-assemble the pump, refer to the assembly instructions below, starting with section "Accessing the shim ring to center the rotor" on page 31

## 18.2 Disassembling the seal system

### 18.2.1 Disassembling the mechanical seal system



To make the procedure clearer, on some pictures the middle housing has been removed. This is not necessary for regular maintenance.

#### Removing the seal system

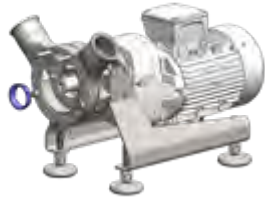

- Carefully remove the back seal face from the mechanical seal system and store it safely.



The seal face with O-ring at the outer diameter, which is installed in the pump housing.

#### Removing the spring assembly

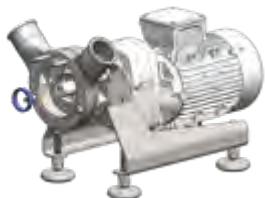

- Remove the spring assembly from the back housing.

## 18.2.2 Disassembling the o-ring seal system



To make the procedure clearer, on some pictures the middle housing has been removed. This is not necessary for regular maintenance.

### Removing the seal system



- Insert the tool (TL-Cxxx-001-50) with the claws into the grooves and turn clockwise by 45°.



- Using the collar on the tool, pull the O-ring holder out of the rear housing. Remove both O-rings as well.



- O-ring holder with 2x O-ring in the front groove and on the outer diameter. Lubricate and install the o-rings. Note: EPDM components cannot withstand oil and grease.

### 18.3 Disassembling the middle housing



The middle housing does not need to be disassembled for changing, for example, the Gate or mechanical seal system. It is only explained here for the sake of completeness.



- Unscrew the nuts which hold the middle housing in place, by turning them counter clockwise.
- Pull the middle housing off the pump.

The assembly procedure of the middle housing is shown in section "Assembling the pump head" on page 34.

### 18.4 Disassembling the back housing/Changing the nozzle orientation

#### 18.4.1 Disassembling the back housing



- Undo the screws on the flange at the back of the housing, by turning them counter clockwise with a wrench.



#### 18.4.2 Changing the nozzle orientation

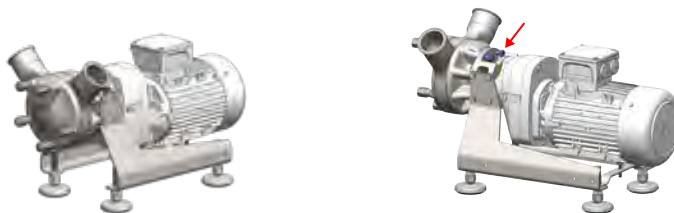

- Undo the screws, by turning counter clockwise with a wrench.



- Rotate the pump housing on the flange to the orientation position you require.
- Tighten the screws by turning clockwise.

### 18.5 Accessing the shim ring to center the rotor



- Take off the shaft key to access the shim ring.

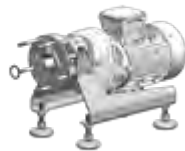

### 18.6 Checking the X-Dimension



The rotor and locking screw need to be fully tightened using the appropriate torque value (see "Tightening torques" on page 41).

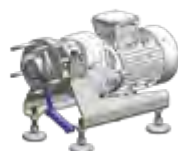

- Check the X-Dimension by measuring the distance from the rotor to the back housing, from the flat part at the peak of the rotor curve.

### 18.6.1 X-Dimension tolerances

If the X-Dimension is not within the tolerances shown in the table below, take out the rotor and gate, using the instructions in "Disassembling the pump" on page 25. Peel off as many layers as needed to get the correct X-Dimension. Each layer is 0.05mm thick.

## 18.7 Assembling the front seal

### 18.7.1 Assembling the front mechanical seal

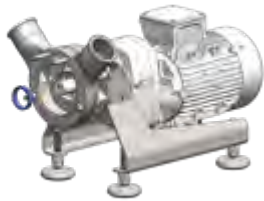

- Install the spring assembly in the pump housing. Make sure the two pins at the back of the ring fit into the two notches in the housing.



**The pins need to match the according notches to prevent the part from rotating.**

- Make sure the spring assembly fits into the two notches. Use a screwdriver or similar tool and move the spring assembly axially. If it is locked, it is in position. If you can turn the ring, turn it carefully until it is possible to push it into the notches.

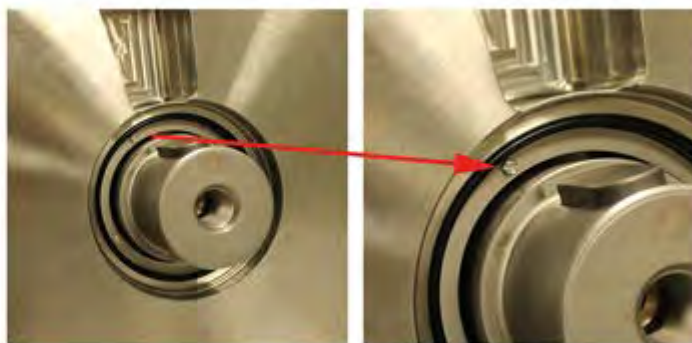

- Fit the O-ring to the inner diameter of the back housing.

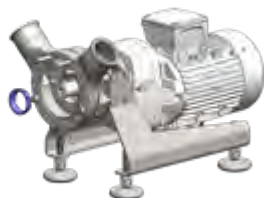

- Assemble the seal face in the housing. Make sure the small pin fits into the notch on the seal face.



**The pins need to match the according notches to prevent the part from rotating.**





- The seal face is in place once a catching can be noticed and the seal face stays in place
- A higher force might be required



**Check for compression of the spring assembly.**

### Fitting the rotor seal system



The seal face for fitting in the rotor, together with the rubber cup.

- Install the rubber cup on the seal face.



- Carefully press the seal face with the side of the cup evenly into the rotor.
- Make sure that the seal face is pushed all the way in, by pressing it as shown. It is recommended to use a hand press or other suitable tools to ensure correct assembly.



### 18.7.2 Assembling the O-Ring seal system



- O-ring receptacle with 2x O-ring in the groove on the face and on the outer diameter. This is inserted into the pump housing. Note: EPDM components cannot withstand oil and grease.



The pins need to match the according notches to prevent the part from rotating.



- Fit the O-ring to the outer diameter of the O-ring holder. For larger pumps, the O-ring can also be inserted into the rear housing.

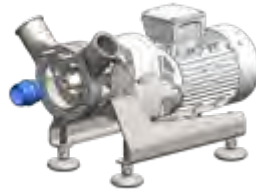

- Insert the O-Ring Seal System with the tool (TL-Cxxx-001-50) into the housing.
- Use the tool to turn the O-ring mount clockwise until the pins on the back noticeably engage in the grooves in the housing and the mount can no longer be turned.
- Use the tool to press the O-ring holder firmly into the rear housing. The Seal Housing is in position when it noticeably engages and holds independently. This may require more force



The pins need to match the according notches to prevent the part from rotating.

## 18.8 Assembling the pump head

### 18.8.1 Assembling the middle housing and the front housing



- Fit the seal in the rear of the middle housing.



You do not need to disassemble the middle housing to change, for example, the Gate or the mechanical seal system. This is only explained for the sake of completeness.



- Make sure you align the slot where the gate is placed with the same slot in the back housing.

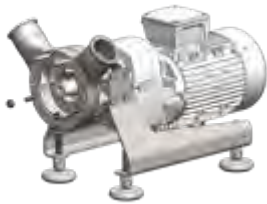

### 18.8.2 Assembling the rotor and gate

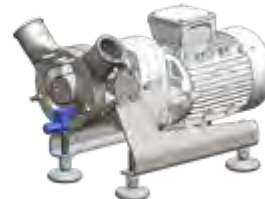

- Assemble the rotor and gate on the shaft.



**Check for compression of the spring assembly.**

- Insert the fixation plate and fasten the screws.



**Mind the lock washers! These need to be replaced every time the screws are opened.**



**Use the appropriate torque value (see "Tightening torques" on page 41).**



**Ensure Disc Springs are oriented properly when placed onto the Locking Screw with cup side pointing away from Locking Screw head. Failure to do so will result in the Locking Screw vibrating loose.**

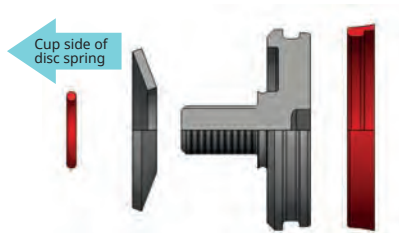

1x Disc Spring C100 Compact- C250 Compact



2x Disc Spring C300 Compact- C600 Compact



Use the appropriate torque value (see "Tightening torques" on page 41)



Locking screw to open with a conventional tool

Locking screw for 3-A and EHEDG to open with the special delivered tool



Hexagonal locking screw with an o-ring



Hexagonal locking screw with gasket

- Fasten the locking screw with the socket adapter. You may need to lock the shaft to prevent it from turning, using the blocking tool (for part codes).



Check if the peaks of the rotor are located slightly behind the front surface of the middle ring.

- Remove the blocking tool.

### 18.8.3 Assembling the front housing

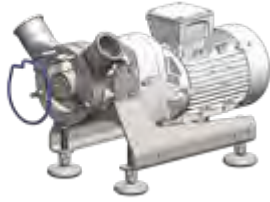

- Fit the seal in the front of the middle housing.



- Attach the front housing. Make sure you align the channel correctly over the gate.

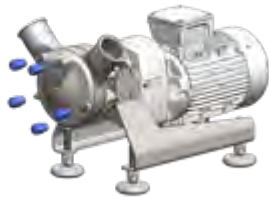

- Tighten the cap nuts by turning them clockwise with a wrench.

### 18.9 Assembling the flush ring of a single mechanical seal system



To access the ring, please follow the instructions on "Disassembling the back housing/Changing the nozzle orientation" on page 30 .

The component parts of the flush ring for the single mechanical seal system.



Flush ring completely assembled with lip seal and O-ring.

The flush ring in the back of the flange. This is used with the single mechanical seal system. A lip seal is placed in the ring in the same way as a flush ring for a flush system.

## 18.10 Assembling the back seal in a double mechanical seal system



The component parts of the back seal assembly.



- Fit the O-ring on the outer diameter of the seal face.
- Assemble the seal face together with the O-ring into the seal holder. Make sure that the pin in the seal holder fits into the notch in the seal face (arrowed).



The pins need to match the according notches to prevent the part from rotating.



- Press the seal face in place into the seal holder.
- Fit the O-ring in the notch on the inner diameter of the seal holder.



The red arrow shows the O-ring in place.



- Put the assembled seal system on the shaft sleeve sitting on the shaft of the gearmotor.



**The pins need to match the according notches to prevent the part from rotating.**



The pin correctly fitted into the notch.



Rear of the back housing showing the location where the back seal assembly of the double mechanical seal system will be installed.

- Install the spring assembly in the rear of the back housing. Make sure that the pins fit into the notches.



**The pins need to match the according notches to prevent the part from rotating.**

For instructions on assembling the parts in the spring assembly, see "Assembling the front seal" on page 32.  
The spring assembly correctly assembled in the rear of the back housing.



**The pins need to match the according notches to prevent the part from rotating.**

- The seal face is in place once a catching can be noticed and the seal face stays in place.
- A higher force might be required.



**Check for compression of the spring assembly.**



- Install the back housing with the assembled seal system on the flange. Make sure you install it in the required orientation. (See "Possible pump orientations" on page 17 .)
- Tighten the screws by turning them clockwise.



The first part of the back seal system installed in the pump back housing.



For an explanation of the assembly procedure for the front seal assembly, please refer to "Assembling the front seal" on page 32.



## 19 Tightening torques

### 19.0.1 C100 Compact

Adjoining parts	Screw type	Torque
Flange—Baseplate / Mounting Bracket	M8 A2 70 DIN 933	16Nm / 16 lb-ft
Flange—Gearmotor	M8 A2 70 DIN 912	16Nm / 12 lb-ft
Back Housing—Threaded plug	R 1/4" DIN 908	25Nm / 18.5 lb-ft
Back housing—Flange	M6 A2 70 DIN 933	7Nm / 5 lb-ft
Shaft—Locking screw	M10x1	45Nm / 33 lb-ft
	For tool sizes See Shaft—Locking screw wrench sizes on page 43 The slotted version for EHEDG / 3-A comes with a special tool	
Front housing—Cap nut	SW22	35Nm / 26 lb-ft

### 19.0.2 C200 Compact

Adjoining parts	Screw type	Torque
Flange—Baseplate / Mounting Bracket	M8 A2 70 DIN 933	16Nm / 16 lb-ft
Flange—Gearmotor	M8 A2 70 DIN 912	16Nm / 12 lb-ft
Back Housing—Threaded plug	R 1/4" DIN 908	25Nm / 18.5 lb-ft
Back housing—Flange	M6 A2 70 DIN 933	7Nm / 5 lb-ft
Shaft—Locking screw	M10x1	45Nm / 33 lb-ft
	For tool sizes See Shaft—Locking screw wrench sizes on page 43 The slotted version for EHEDG / 3-A comes with a special tool	
Front housing—Cap nut	SW22	35Nm / 26 lb-ft

### 19.0.3 C250 Compact

Adjoining parts	Screw type	Torque
Flange—Baseplate / Mounting Bracket	M10 A2 70 DIN 933	33Nm / 24.5 lb-ft
Flange—Gearmotor	M8 A2 70 DIN 912	16Nm / 12 lb-ft
Back Housing—Threaded plug	R 1/4" DIN 908	25Nm / 18.5 lb-ft
Back housing—Flange	M10 A2 70 DIN 933	33Nm / 24.5 lb-ft
Shaft—Locking screw	M16x1,5	70Nm / 51.5 lb-ft
	For tool sizes See Shaft—Locking screw wrench sizes on page 43 The slotted version for EHEDG / 3-A comes with a special tool	
Front housing—Cap nut	SW22	45Nm / 33 lb-ft

### 19.0.4 C300 Compact

Adjoining parts	Screw type	Torque
Flange—Baseplate / Mounting Bracket	M10 A2 70 DIN 933	33Nm / 24.5 lb-ft
Flange—Gearmotor	M8 A2 70 DIN 912	16Nm / 12 lb-ft
Back Housing—Threaded plug	R 1/4" DIN 908	25Nm / 18.5 lb-ft
Back housing—Flange	M10 A2 70 DIN 933	33Nm / 24.5 lb-ft
Shaft—Locking screw	M20x1,5	120Nm / 88.5 lb-ft
	For tool sizes See Shaft—Locking screw wrench sizes on the next page	
	The slotted version for EHEDG / 3-A comes with a special tool	
Front housing—Cap nut	SW22	45Nm / 33 lb-ft

### 19.0.5 C400 Compact

Adjoining parts	Screw type	Torque
Flange—Baseplate / Mounting Bracket	M12 A2 70 DIN 933	56Nm / 41.5 lb-ft
Flange—Gearmotor	M12 A2 70 DIN 912	56Nm / 41.5 lb-ft
Back Housing—Threaded plug	R 1/4" DIN 908	25Nm / 18.5 lb-ft
Back housing—Flange	M10 A2 70 DIN 933	33Nm / 24.5 lb-ft
Shaft—Locking screw	M20x1,5	120Nm / 88.5 lb-ft
	For tool sizes See Shaft—Locking screw wrench sizes on the next page	
	The slotted version for EHEDG / 3-A comes with a special tool	
Front housing—Cap nut	SW22	56Nm / 41.5 lb-ft

### 19.0.6 C500 Compact

Adjoining parts	Screw type	Torque
Flange—Baseplate / Mounting Bracket	M12 A2 70 DIN 933	56Nm / 41.5 lb-ft
Flange—Gearmotor	M12 A2 70 DIN 912	56Nm / 41.5 lb-ft
Back Housing—Threaded plug	R 1/4" DIN 908	25Nm / 18.5 lb-ft
Back housing—Flange	M12 A2 70 DIN 933	56Nm / 41.5 lb-ft
Shaft—Locking screw	M24x2	200Nm / 147.5 lb-ft
	For tool sizes See Shaft—Locking screw wrench sizes on the next page	
	The slotted version for EHEDG / 3-A comes with a special tool	
Front housing—Cap nut	SW30	135Nm / 99.5 lb-ft

### 19.0.7 C600 Compact

Adjoining parts	Screw type	Torque
Flange—Baseplate / Mounting Bracket	M20 A2 70 DIN 933	180 Nm / 132.5 lb-ft
Flange—Gearmotor	M16 A2 70 DIN 912	135Nm / 99.5 lb-ft
Back Housing—Threaded plug	R 1/4" DIN 908	25Nm / 18.5 lb-ft
Back housing—Flange	M16 A2 70 DIN 933	135Nm / 99.5 lb-ft
Shaft—Locking screw	M24x2	200Nm / 147.5 lb-ft
	For tool sizes See Shaft—Locking screw wrench sizes below The slotted version for EHEDG / 3-A comes with a special tool	
Front housing—Cap nut	SW30	135Nm / 99.5 lb-ft

### 19.1 Shaft—Locking screw wrench sizes

Required wrench size for hexagonal locking screw		
Pump size	Metric	Inch
C100 Compact/C200 Compact	SW14	9/16"
C250 Compact	SW19	3/4"
C300 Compact/C400 Compact	SW34	1 5/16"
C500 Compact/C600 Compact	SW38	1 1/2"

## 20 Parts lists

With the exception of the codes for springs, part codes are composed of three sections in the form:  
xxxx-yyy-zz

Where,

xxxx is the pump type

yyy is the part

zz is the material

Where ## appears instead of an alphanumeric code in positions zz, select from the table below.

## 20.1 Pumps

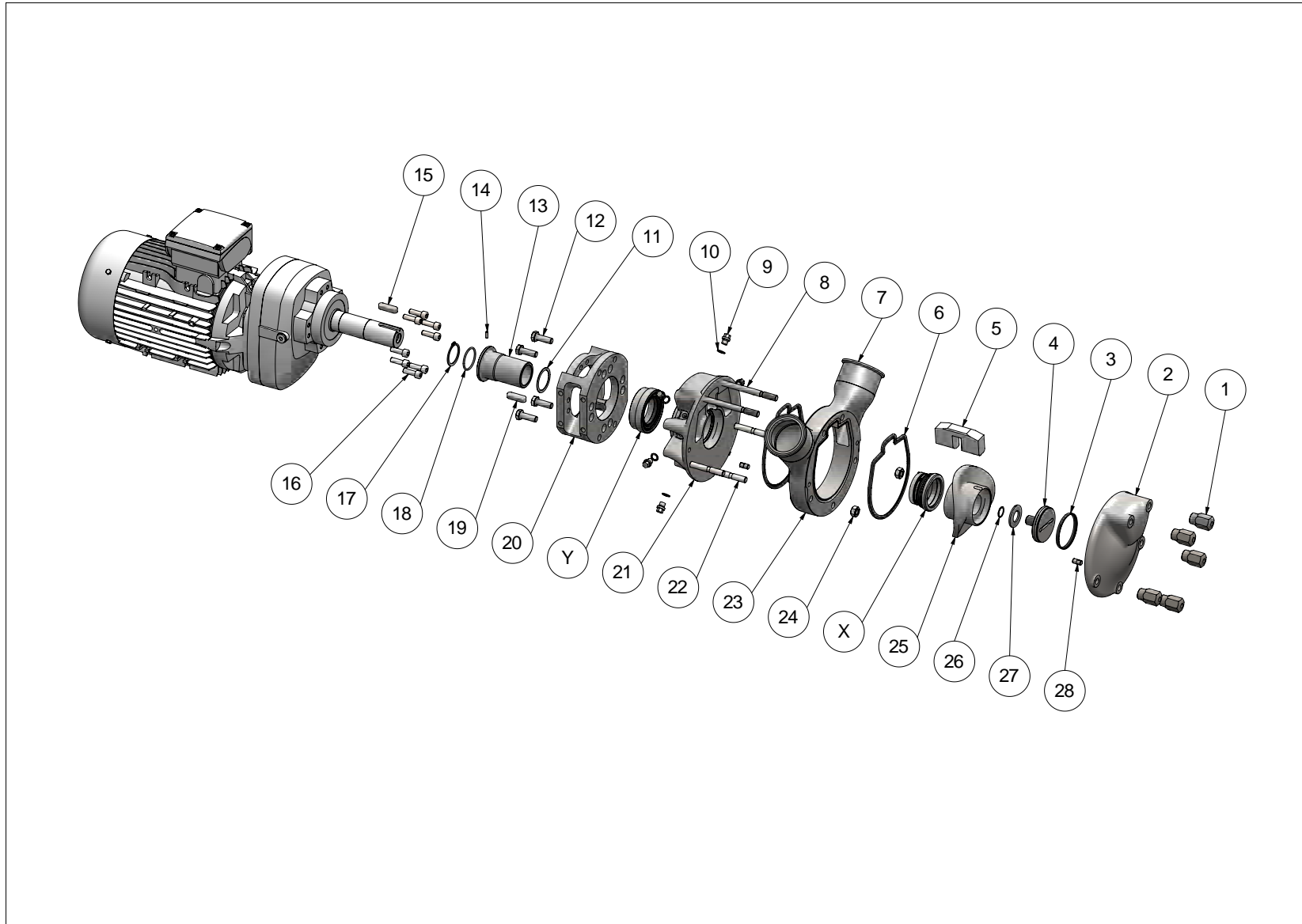

## 20.1.1 C100 Compact

Number	Quantity	Part code	Item
1	5	C100-1600-12	Cap Nut
2	1	C100-0200-10	Front housing
3	1	C100-1752-82	Sealing for locking screw, EPDM
		C100-1752-84	Sealing for locking screw, FKM
		C100-1752-84MD	Sealing for locking screw, FKM metaldetectable
		C100-1754-82	O-Ring for COP applications, EPDM
		C100-1754-84	O-Ring for COP applications, FKM
4	1	C100-1100-10	Locking screw
		C100-1103-10	Locking screw with hexagon
5	1	C100-0400-43	Gate, POM metaldetectable
		C100-0400-46	Gate, MWR
		C100-0400-47	Gate, PTFE
		C100-0400-49	Gate, WRP
		C100-0400-49PU	Gate, WRP - PUR-Inlay
		C100-0400-50	Gate, PA
		C100-0400-52	Gate, PA6GF30
		C100-0400-59USP	Gate, PN
6	2	C100-1750-82	Seal, pump housing, EPDM
		C100-1750-84	Seal, pump housing, FKM
		C100-1750-84MD	Seal, pump housing, FKM metaldetectable
7	2	-	Nozzle (on customer request)
8	2	C100-1850-12	Stud
9	6	C100-9002-12	Threaded plug
10	6	C100-2100-33	Sealing ring
11	1	C100-1405-12	Shim ring
12	4	C100-1950-12	Hexagon screw
13	1	C100-1050-10	Shaft sleeve
14	1	C100-0601-12	Set screw
15	1	C100-3250-12	Shaft key
16	8	C100-2250-12	Socket head cap screw
17		-	(not required)
18	1	C100-0602-80	O-Ring, NBR
19		-	(not required)
20	1	C100-1305-12	Flange
21	1	C100-0350-10	Back housing
22	3	C100-1800-12	Stud
23	1	C100-0300-10	Middle housing
24	2	C100-1805-12	Hexagon nut

Number	Quantity	Part code	Item
25	1	C100-0100-06	Rotor, A276/CF10SMnN
		C100-0100-08	Rotor, A494/CY5SnBiM
26	1	C100-1112-80	O-Ring, NBR
27	1	C100-1150-12	Disc spring
28	4	C100-0301-12	Pin
X	1		Sealing System
Y	1		Atmospheric Seal

### Available wearing kits

#### O-Ring Kit for pumps with (X) mechanical seal

part code	item	including
C100-1700-82	O-Ring Kit, EPDM	
C100-1700-84	O-Ring Kit, FKM	2x Pos. 3 1x Pos. 6 1x Pos. 63
C100-1700-84MD	O-Ring Kit, FKM metaldetectable	

#### O-Ring Kit for pumps with (X) O-Ring Seal

part code	item	including
C100-1715-82	O-Ring Kit, EPDM	2x Pos. 3 1x Pos. 6 2x Pos. 63
C100-1715-84	O-Ring Kit, FKM	

#### O-Ring Kit for pumps with (X) O-Ring Seal and COP application

part code	item	including
C100-1716-82	O-Ring Kit, EPDM	2x Pos. 3 1x Pos. 6 2x Pos. 63
C100-1716-84	O-Ring Kit, FKM	

## 20.1.2 C200 Compact

Number	Quantity	Part code	Item
1	5	C200-1600-12	Cap Nut
2	1	C200-0200-10	Front housing
3	1	C200-1752-82	Sealing for locking screw, EPDM
		C200-1752-84	Sealing for locking screw, FKM
		C200-1752-84MD	Sealing for locking screw, FKM metaldetectable
		C200-1754-82	O-Ring for COP applications, EPDM
		C200-1754-84	O-Ring for COP applications, FKM
4	1	C200-1100-10	Locking screw
		C200-1103-10	Locking screw with hexagon
5	1	C200-0400-43	Gate, POM metaldetectable
		C200-0400-46	Gate, MWR
		C200-0400-47	Gate, PTFE
		C200-0400-49	Gate, WRP
		C200-0400-49PU	Gate, WRP - PUR-Inlay
		C200-0400-50	Gate, PA
		C200-0400-52	Gate, PA6GF30
		C200-0400-59USP	Gate, PN
6	2	C200-1750-82	Seal, pump housing, EPDM
		C200-1750-84	Seal, pump housing, FKM
		C200-1750-84MD	Seal, pump housing, FKM metaldetectable
7	2	-	Nozzle (on customer request)
8	2	C200-1850-12	Stud
9	6	C200-9002-12	Threaded plug
10	6	C200-2100-33	Sealing ring
11	1	C200-1405-12	Shim ring
12	4	C200-1950-12	Hexagon screw
13	1	C200-1050-10	Shaft sleeve
14	1	C200-0601-12	Set screw
15	1	C200-3250-12	Shaft key
16	8	C200-2250-12	Socket head cap screw
17	-	-	(not required)
18	1	C200-0602-80	O-Ring, NBR
19	-	-	(not required)
20	1	C200-1305-12	Flange
21	1	C200-0350-10	Back housing
22	3	C200-1800-12	Stud
23	1	C200-0300-10	Middle housing
24	2	C200-1805-12	Hexagon nut

Number	Quantity	Part code	Item
25	1	C200-0100-06	Rotor, A276/CF10SMnN
		C200-0100-08	Rotor, A494/CY5SnBiM
26	1	C200-1112-80	O-Ring, NBR
27	1	C200-1150-12	Disc spring
28	4	C200-0301-12	Pin
X	1	-	Sealing System
Y	1	-	Atmospheric Seal

### Available wearing kits

O-Ring Kit for pumps with (X) mechanical seal		
part code	item	including
C200-1700-82	O-Ring Kit, EPDM	
C200-1700-84	O-Ring Kit, FKM	2x Pos. 3 1x Pos. 6 1x Pos. 63
C200-1700-84MD	O-Ring Kit, FKM metaldetectable	

O-Ring Kit for pumps with (X) mechanical seal		
part code	item	including
C200-1715-82	O-Ring Kit, EPDM	
C200-1715-84	O-Ring Kit, FKM	2x Pos. 3 1x Pos. 6 2x Pos. 63

O-Ring Kit for pumps with (X) mechanical seal		
part code	item	including
C200-1716-82	O-Ring Kit, EPDM	
C200-1716-84	O-Ring Kit, FKM	2x Pos. 3 1x Pos. 6 2x Pos. 63

### 20.1.3 C250 Compact

Number	Quantity	Part code	Item
1	5	C250-1600-12	Cap Nut
2	1	C250-0200-10	Front housing
3	1	C250-1752-82	Sealing for locking screw, EPDM
		C250-1752-84	Sealing for locking screw, FKM
		C250-1752-84MD	Sealing for locking screw, FKM metaldetectable
		C250-1754-82	O-Ring for COP applications, EPDM
4	1	C250-1754-84	O-Ring for COP applications, FKM
		C250-1100-10	Locking screw
5	1	C250-1103-10	Locking screw with hexagon
		C250-0400-43	Gate, POM metaldetectable
		C250-0400-46	Gate, MWR
		C250-0400-47	Gate, PTFE
		C250-0400-49	Gate, WRP
		C250-0400-49PU	Gate, WRP - PUR-Inlay
		C250-0400-50	Gate, PA
		C250-0400-52	Gate, PA6GF30
6	2	C250-0400-59USP	Gate, PN
		C250-1750-82	Seal, pump housing, EPDM
		C250-1750-84	Seal, pump housing, FKM
7	2	C250-1750-84MD	Seal, pump housing, FKM metaldetectable
		-	Nozzle (on customer request)
8	2	C250-1850-12	Stud
9	6	C250-9002-12	Threaded plug
10	6	C250-2100-33	Sealing ring
11	1	C250-1405-12	Shim ring
12	4	C250-1950-12	Hexagon screw
13	1	C250-1050-10	Shaft sleeve
14	-	-	(not required)
15	1	C250-3250-12	Shaft key
16	8	C250-2250-12	Socket head cap screw
17	-	-	(not required)
18	1	C250-0602-80	O-Ring, NBR
19	-	-	(not required)
20	1	C250-1305-12	Flange
21	1	C250-0350-10	Back housing
22	3	C250-1800-12	Stud
23	1	C250-0300-10	Middle housing
24	2	C250-1805-12	Hexagon nut

Number	Quantity	Part code	Item
25	1	C250-0100-06	Rotor, A276/CF10SMnN
		C250-0100-08	Rotor, A494/CY5SnBiM
26	1	C250-1112-80	O-Ring, NBR
27	1	C250-1150-12	Disc spring
28	4	C250-0301-12	Pin
X	1	-	Sealing System
Y	1	-	Atmospheric Seal

#### Available wearing kits

O-Ring Kit for pumps with (X) mechanical seal		
part code	item	including
C250-1700-82	O-Ring Kit, EPDM	
C250-1700-84	O-Ring Kit, FKM	2x Pos. 3 1x Pos. 6 1x Pos. 63
C250-1700-84MD	O-Ring Kit, FKM metaldetectable	

O-Ring Kit for pumps with (X) mechanical seal		
part code	item	including
C250-1715-82	O-Ring Kit, EPDM	
C250-1715-84	O-Ring Kit, FKM	2x Pos. 3 1x Pos. 6 2x Pos. 63

O-Ring Kit for pumps with (X) mechanical seal		
part code	item	including
C250-1716-82	O-Ring Kit, EPDM	
C250-1716-84	O-Ring Kit, FKM	2x Pos. 3 1x Pos. 6 2x Pos. 63



## 20.1.4 C300 Compact

Number	Quantity	Part code	Item
1	5	C300-1600-12	Cap Nut
2	1	C300-0200-10	Front housing
3	1	C300-1752-82	Sealing for locking screw, EPDM
		C300-1752-84	Sealing for locking screw, FKM
		C300-1752-84MD	Sealing for locking screw, FKM metaldetectable
		C300-1754-82	O-Ring for COP applications, EPDM
		C300-1754-84	O-Ring for COP applications, FKM
4	1	C300-1100-10	Locking screw
		C300-1103-10	Locking screw with hexagon
5	1	C300-0400-43	Gate, POM metaldetectable
		C300-0400-46	Gate, MWR
		C300-0400-47	Gate, PTFE
		C300-0400-49	Gate, WRP
		C300-0400-49PU	Gate, WRP - PUR-Inlay
		C300-0400-50	Gate, PA
		C300-0400-52	Gate, PA6GF30
		C300-0400-59USP	Gate, PN
6	2	C300-1750-82	Seal, pump housing, EPDM
		C300-1750-84	Seal, pump housing, FKM
		C300-1750-84MD	Seal, pump housing, FKM metaldetectable
7	2	-	Nozzle (on customer request)
8	2	C300-1850-12	Stud
9	6	C300-9002-12	Threaded plug
10	6	C300-2100-33	Sealing ring
11	1	C300-1405-12	Shim ring
12	4	C300-1950-12	Hexagon screw
13	1	C300-1050-10	Shaft sleeve
14	-	-	(not required)
15	1	C300-3250-12	Shaft key
16	8	C300-2250-12	Socket head cap screw
17	1	C300-0603-10	Snap ring
18	1	C300-0602-80	O-Ring, NBR
19	-	-	(not required)
20	1	C300-1305-12	Flange
21	1	C300-0350-10	Back housing
22	3	C300-1800-12	Stud
23	1	C300-0300-10	Middle housing
24	2	C300-1805-12	Hexagon nut

Number	Quantity	Part code	Item
25	1	C300-0100-06	Rotor, A276/CF10SMnN
		C300-0100-08	Rotor, A494/CY5SnBiM
26	1	C300-1112-80	O-Ring, NBR
27	2	C300-1150-12	Disc spring
28	4	C300-0301-12	Pin
X	1	-	Sealing System
Y	1	-	Atmospheric Seal

### Available wearing kits

O-Ring Kit for pumps with (X) mechanical seal		
part code	item	including
C300-1700-82	O-Ring Kit, EPDM	
C300-1700-84	O-Ring Kit, FKM	2x Pos. 3 1x Pos. 6 1x Pos. 63
C300-1700-84MD	O-Ring Kit, FKM metaldetectable	

O-Ring Kit for pumps with (X) O-Ring Seal		
part code	item	including
C300-1715-82	O-Ring Kit, EPDM	2x Pos. 3 1x Pos. 6 2x Pos. 63
C300-1715-84	O-Ring Kit, FKM	

O-Ring Kit for pumps with (X) O-Ring Seal		
part code	item	including
C300-1716-82	O-Ring Kit, EPDM	2x Pos. 3 1x Pos. 6 2x Pos. 63
C300-1716-84	O-Ring Kit, FKM	

## 20.1.5 C400 Compact

Number	Quantity	Part code	Item
1	5	C400-1600-12	Cap Nut
2	1	C400-0200-10	Front housing
3	1	C400-1752-82	Sealing for locking screw, EPDM
		C400-1752-84	Sealing for locking screw, FKM
		C400-1752-84MD	Sealing for locking screw, FKM metaldetectable
		C400-1754-82	O-Ring for COP applications, EPDM
		C400-1754-84	O-Ring for COP applications, FKM
4	1	C400-1100-10	Locking screw
		C400-1103-10	Locking screw with hexagon
5	1	C400-0400-43	Gate, POM metaldetectable
		C400-0400-46	Gate, MWR
		C400-0400-47	Gate, PTFE
		C400-0400-49	Gate, WRP
		C400-0400-49PU	Gate, WRP - PUR-Inlay
		C400-0400-50	Gate, PA
		C400-0400-52	Gate, PA6GF30
		C400-0400-59USP	Gate, PN
6	2	C400-1750-82	Seal, pump housing, EPDM
		C400-1750-84	Seal, pump housing, FKM
		C400-1750-84MD	Seal, pump housing, FKM metaldetectable
7	2	-	Nozzle (on customer request)
8	2	C400-1850-12	Stud
9	6	C400-9002-12	Threaded plug
10	6	C400-2100-33	Sealing ring
11	1	C400-1405-12	Shim ring
12	4	C400-1950-12	Hexagon screw
13	1	C400-1050-10	Shaft sleeve
14	-	-	(not required)
15	1	C400-3250-12	Shaft key
16	8	C400-2250-12	Socket head cap screw
17	-	-	(not required)
18	1	C400-0602-80	O-Ring, NBR
19	-	-	(not required)
20	1	C400-1305-12	Flange
21	1	C400-0350-10	Back housing
22	3	C400-1800-12	Stud
23	1	C400-0300-10	Middle housing
24	2	C400-1805-12	Hexagon nut

Number	Quantity	Part code	Item
25	1	C400-0100-06	Rotor, A276/CF10SMnN
		C400-0100-08	Rotor, A494/CY5SnBiM
26	1	C400-1112-80	O-Ring, NBR
27	2	C400-1150-12	Disc spring
28	4	C400-0301-12	Pin
X	1	-	Sealing System
Y	1	-	Atmospheric Seal

### Available wearing kits

O-Ring Kit for pumps with (X) O-Ring Seal and COP application		
part code	item	including
C400-1700-82	O-Ring Kit, EPDM	
C400-1700-84	O-Ring Kit, FKM	2x Pos. 3 1x Pos. 6 1x Pos. 63
C400-1700-84MD	O-Ring Kit, FKM metaldetectable	

O-Ring Kit for pumps with (X) O-Ring Seal and COP application		
part code	item	including
C400-1715-82	O-Ring Kit, EPDM	
C400-1715-84	O-Ring Kit, FKM	2x Pos. 3 1x Pos. 6 2x Pos. 63

O-Ring Kit for pumps with (X) O-Ring Seal and COP application		
part code	item	including
C400-1716-82	O-Ring Kit, EPDM	
C400-1716-84	O-Ring Kit, FKM	2x Pos. 3 1x Pos. 6 2x Pos. 63

## 20.1.6 C500 Compact

Number	Quantity	Part code	Item
1	5	C500-1600-12	Cap Nut
2	1	C500-0200-10	Front housing
3	1	C500-1752-82	Sealing for locking screw, EPDM
		C500-1752-84	Sealing for locking screw, FKM
		C500-1752-84MD	Sealing for locking screw, FKM metaldetectable
		C500-1754-82	O-Ring for COP applications, EPDM
		C500-1754-84	O-Ring for COP applications, FKM
4	1	C500-1100-10	Locking screw
		C500-1103-10	Locking screw with hexagon
5	1	C500-0400-43	Gate, POM metaldetectable
		C500-0400-46	Gate, MWR
		C500-0400-47	Gate, PTFE
		C500-0400-49	Gate, WRP
		C500-0400-49PU	Gate, WRP - PUR-Inlay
		C500-0400-50	Gate, PA
		C500-0400-52	Gate, PA6GF30
		C500-0400-59USP	Gate, PN
6	2	C500-1750-82	Seal, pump housing, EPDM
		C500-1750-84	Seal, pump housing, FKM
		C500-1750-84MD	Seal, pump housing, FKM metaldetectable
7	2	-	Nozzle (on customer request)
8	2	C500-1850-12	Stud
9	6	C500-9002-12	Threaded plug
10	6	C500-2100-33	Sealing ring
11	1	C500-1405-12	Shim ring
12	4	C500-1950-12	Hexagon screw
13	1	C500-1050-10	Shaft sleeve
14	-	-	(not required)
15	1	C500-3250-12	Shaft key
16	8	C500-2250-12	Socket head cap screw
17	-	-	(not required)
18	1	C500-0602-80	O-Ring, NBR
19	1	C500-3255-12	Shaft key
20	1	C500-1305-12	Flange
21	1	C500-0350-10	Back housing
22	3	C500-1800-12	Stud
23	1	C500-0300-10	Middle housing
24	2	C500-1805-12	Hexagon nut

Number	Quantity	Part code	Item
25	1	C500-0100-06	Rotor, A276/CF10SMnN
		C500-0100-08	Rotor, A494/CY5SnBiM
26	1	C500-1112-80	O-Ring, NBR
27	2	C500-1150-12	Disc spring
28	4	C500-0301-12	Pin
X	1	-	Sealing System
Y	1	-	Atmospheric Seal

### Available wearing kits

O-Ring Kit for pumps with (X) mechanical seal		
part code	item	including
C500-1700-82	O-Ring Kit, EPDM	
C500-1700-84	O-Ring Kit, FKM	2x Pos. 3 1x Pos. 6 1x Pos. 63
C500-1700-84MD	O-Ring Kit, FKM metaldetectable	

O-Ring Kit for pumps with (X) O-Ring Seal		
part code	item	including
C500-1715-82	O-Ring Kit, EPDM	2x Pos. 3 1x Pos. 6 2x Pos. 63
C500-1715-84	O-Ring Kit, FKM	

O-Ring Kit for pumps with (X) O-Ring Seal and COP application		
part code	item	including
C500-1716-82	O-Ring Kit, EPDM	2x Pos. 3 1x Pos. 6 2x Pos. 63
C500-1716-84	O-Ring Kit, FKM	

## 20.1.7 C600 Compact

Number	Quantity	Part code	Item
1	5	C600-1600-12	Cap Nut
2	1	C600-0200-10	Front housing
3	1	C600-1752-82	Sealing for locking screw, EPDM
		C600-1752-84	Sealing for locking screw, FKM
		C600-1752-84MD	Sealing for locking screw, FKM metaldetectable
		C600-1754-82	O-Ring for COP applications, EPDM
4	1	C600-1754-84	O-Ring for COP applications, FKM
		C600-1100-10	Locking screw
5	1	C600-1103-10	Locking screw with hexagon
		C600-0400-43	Gate, POM metaldetectable
		C600-0400-46	Gate, MWR
		C600-0400-47	Gate, PTFE
		C600-0400-49	Gate, WRP
		C600-0400-49PU	Gate, WRP - PUR-Inlay
		C600-0400-50	Gate, PA
		C600-0400-52	Gate, PA6GF30
6	2	C600-0400-59USP	Gate, PN
		C600-1750-82	Seal, pump housing, EPDM
		C600-1750-84	Seal, pump housing, FKM
7	2	C600-1750-84MD	Seal, pump housing, FKM metaldetectable
		-	Nozzle (on customer request)
8	2	C600-1850-12	Stud
9	6	C600-9002-12	Threaded plug
10	6	C600-2100-33	Sealing ring
11	1	C600-1405-12	Shim ring
12	4	C600-1950-12	Hexagon screw
13	1	C600-1050-10	Shaft sleeve
14	-	-	(not required)
15	1	C600-3250-12	Shaft key
16	8	C600-2250-12	Socket head cap screw
17	1	C600-0603-10	Snap ring
18	1	C600-0602-80	O-Ring, NBR
19	-	-	(not required)
20	1	C600-1305-12	Flange
21	1	C600-0350-10	Back housing
22	3	C600-1800-12	Stud
23	1	C600-0300-10	Middle housing
24	2	C600-1805-12	Hexagon nut

Number	Quantity	Part code	Item
25	1	C600-0100-06	Rotor, A276/CF10SMnN
		C600-0100-08	Rotor, A494/CY5SnBiM
26	1	C600-1112-80	O-Ring, NBR
27	2	C600-1150-12	Disc spring
28	4	C600-0301-12	Pin
X	1	-	Sealing System
Y	1	-	Atmospheric Seal

### Available wearing kits

O-Ring Kit for pumps with (X) mechanical seal		
part code	item	including
C600-1700-82	O-Ring Kit, EPDM	
C600-1700-84	O-Ring Kit, FKM	2x Pos. 3 1x Pos. 6 1x Pos. 63
C600-1700-84MD	O-Ring Kit, FKM metaldetectable	

O-Ring Kit for pumps with (X) O-Ring Seal		
part code	item	including
C600-1715-82	O-Ring Kit, EPDM	
C600-1715-84	O-Ring Kit, FKM	2x Pos. 3 1x Pos. 6 2x Pos. 63

O-Ring Kit for pumps with (X) O-Ring Seal and COP application		
part code	item	including
C600-1716-82	O-Ring Kit, EPDM	
C600-1716-84	O-Ring Kit, FKM	2x Pos. 3 1x Pos. 6 2x Pos. 63

## 20.2 Sealing System (Pos. X)



### 20.2.1 Wearing kit

Part Code	Item	Including
Cxxx-0660-95	Wearing Kit, SiC/SiC, FKM	
Cxxx-0660-95EP	Wearing Kit, SiC/SiC, EPDM	
Cxxx-0660-95MD	Wearing Kit, SiC/SiC, FKM metaldetectable	1x Pos. 60 1x Pos. 61 1x Pos. 63
Cxxx-0660-97	Wearing Kit, SiC/CA, FKM	
Cxxx-0660-97EP	Wearing Kit, SiC/CA, EPDM	
Cxxx-0660-97MD	Wearing Kit, SiC/CA, FKM metaldetectable	

### 20.2.2 C100 Compact

Number	Quantity	Part Code	Item
60	1	C100-5240-88	Dynamic face, SiC, PTFE Cup
61	1	C100-5245-41	Static face, SiC
		C100-5245-66	Static face, CA
		C100-5246-82	O-Ring, EPDM
63	1	C100-5246-84	O-Ring, FKM
		C100-5246-84MD	O-Ring, FKM metaldetectable
69	1	C100-5220-10	Spring Assembly

### 20.2.3 C200 Compact

Number	Quantity	Part Code	Item
60	1	C200-5240-88	Dynamic face, SiC, PTFE Cup
61	1	C200-5245-41	Static face, SiC
		C200-5245-66	Static face, CA
		C200-5246-82	O-Ring, EPDM
63	1	C200-5246-84	O-Ring, FKM
		C200-5246-84MD	O-Ring, FKM metaldetectable
69	1	C200-5220-10	Spring Assembly

### 20.2.4 C250 Compact

Number	Quantity	Part Code	Item
60	1	C250-5240-88	Dynamic face, SiC, PTFE Cup
61	1	C250-5245-41	Static face, SiC
		C250-5245-66	Static face, CA
		C250-5246-82	O-Ring, EPDM
63	1	C250-5246-84	O-Ring, FKM
		C250-5246-84MD	O-Ring, FKM metaldetectable
69	1	C250-5220-10	Spring Assembly

### 20.2.5 C300 Compact

Number	Quantity	Part Code	Item
60	1	C300-5240-88	Dynamic face, SiC, PTFE Cup
61	1	C300-5245-41	Static face, SiC
		C300-5245-66	Static face, CA
		C300-5246-82	O-Ring, EPDM
63	1	C300-5246-84	O-Ring, FKM
		C300-5246-84MD	O-Ring, FKM metaldetectable
69	1	C300-5220-10	Spring Assembly

### 20.2.6 C400 Compact

Number	Quantity	Part Code	Item
60	1	C400-5240-88	Dynamic face, SiC, PTFE Cup
61	1	C400-5245-41	Static face, SiC
		C400-5245-66	Static face, CA
		C400-5246-82	O-Ring, EPDM
63	1	C400-5246-84	O-Ring, FKM
		C400-5246-84MD	O-Ring, FKM metaldetectable
69	1	C400-5220-10	Spring Assembly

### 20.2.7 C500 Compact

Number	Quantity	Part Code	Item
60	1	C500-5240-88	Dynamic face, SiC, PTFE Cup
61	1	C500-5245-41	Static face, SiC
		C500-5245-66	Static face, CA
63	1	C500-5246-82	O-Ring, EPDM
		C500-5246-84	O-Ring, FKM
		C500-5246-84MD	O-Ring, FKM metaldetectable
69	1	C500-5220-10	Spring Assembly

### 20.2.8 C600 Compact

Number	Quantity	Part Code	Item
60	1	C600-5240-88	Dynamic face, SiC, PTFE Cup
61	1	C600-5245-41	Static face, SiC
		C600-5245-66	Static face, CA
63	1	C600-5246-82	O-Ring, EPDM
		C600-5246-84	O-Ring, FKM
		C600-5246-84MD	O-Ring, FKM metaldetectable
69	1	C600-5220-10	Spring Assembly

## 20.3 Atmospheric Seal (Pos. Y)

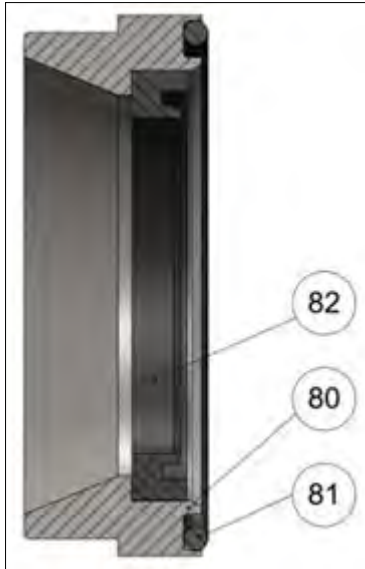

### 20.3.1 C100 Compact

Number	Quantity	Part Code	Item
80	1	C100-1308-10	Distance Ring
81	1	C100-1755-80	O-Ring, NBR
82	1	C100-2340-80	Lip Seal, NBR

### 20.3.2 C200 Compact

Number	Quantity	Part Code	Item
80	1	C200-1308-10	Distance Ring
81	1	C200-1755-80	O-Ring, NBR
82	1	C200-2340-80	Lip Seal, NBR

### 20.3.3 C250 Compact

Number	Quantity	Part Code	Item
80	1	C250-1308-10	Distance Ring
81	1	C250-1755-80	O-Ring, NBR
82	1	C250-2340-80	Lip Seal, NBR

### 20.3.4 C300 Compact

Number	Quantity	Part Code	Item
80	1	C300-1308-10	Distance Ring
81	1	C300-1755-80	O-Ring, NBR
82	1	C300-2340-80	Lip Seal, NBR

### 20.3.5 C400 Compact

Number	Quantity	Part Code	Item
80	1	C400-1308-10	Distance Ring
81	1	C400-1755-80	O-Ring, NBR
82	1	C400-2340-80	Lip Seal, NBR

### 20.3.6 C500 Compact

Number	Quantity	Part Code	Item
80	1	C500-1308-10	Distance Ring
81	1	C500-1755-80	O-Ring, NBR
82	1	C500-2340-80	Lip Seal, NBR

### 20.3.7 C600 Compact

Number	Quantity	Part Code	Item
80	1	C600-1308-10	Distance Ring
81	1	C600-1755-80	O-Ring, NBR
82	1	C600-2340-80	Lip Seal, NBR

## 20.4 Double Mechanical Seal (Pos. Y)

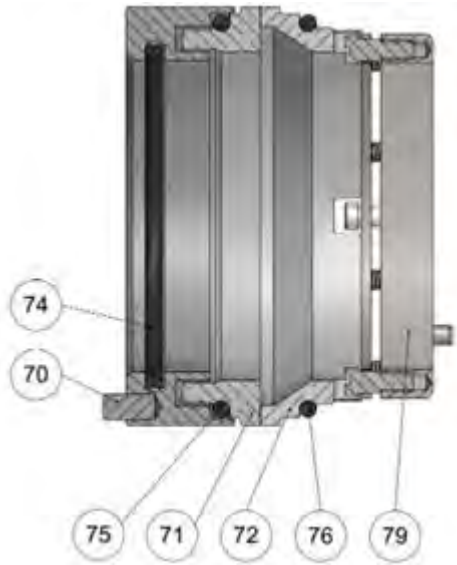

### 20.4.1 Wearing Kit

Part Code	Item	including
Cxxx-0665-95	Wearing Kit, SiC/SiC, FKM	1x Pos. 71 1x Pos. 72 1x Pos. 74
Cxxx-0665-95EP	Wearing Kit, SiC/SiC, EPDM	1x Pos. 75 1x Pos. 76

### 20.4.2 C100 Compact

Number	Quantity	Part Code	Item
70	1	C100-5310-10	Dynamic ring holder
71	1	C100-5340-41	Dynamic face, SiC
72	1	C100-5345-41	Static face, SiC
74	1	C100-5311-82	O-Ring, EPDM
		C100-5311-84	O-Ring, FKM
75	1	C100-5341-82	O-Ring, EPDM
		C100-5341-84	O-Ring, FKM
76	1	C100-5346-82	O-Ring, EPDM
		C100-5346-84	O-Ring, FKM
79	1	C100-5320-10	Spring assembly

### 20.4.3 C200 Compact

Number	Quantity	Part Code	Item
70	1	C200-5310-10	Dynamic ring holder
71	1	C200-5340-41	Dynamic face, SiC
72	1	C200-5345-41	Static face, SiC
74	1	C200-5311-82	O-Ring, EPDM
		C200-5311-84	O-Ring, FKM
75	1	C200-5341-82	O-Ring, EPDM
		C200-5341-84	O-Ring, FKM
76	1	C200-5346-82	O-Ring, EPDM
		C200-5346-84	O-Ring, FKM
79	1	C200-5320-10	Spring assembly

### 20.4.4 C250 Compact

Number	Quantity	Part Code	Item
70	1	C250-5310-10	Dynamic ring holder
71	1	C250-5340-41	Dynamic face, SiC
72	1	C250-5345-41	Static face, SiC
74	1	C250-5311-82	O-Ring, EPDM
		C250-5311-84	O-Ring, FKM
75	1	C250-5341-82	O-Ring, EPDM
		C250-5341-84	O-Ring, FKM
76	1	C250-5346-82	O-Ring, EPDM
		C250-5346-84	O-Ring, FKM
79	1	C250-5320-10	Spring assembly

### 20.4.5 C300 Compact

Number	Quantity	Part Code	Item
70	1	C300-5310-10	Dynamic ring holder
71	1	C300-5340-41	Dynamic face, SiC
72	1	C300-5345-41	Static face, SiC
74	1	C300-5311-82	O-Ring, EPDM
		C300-5311-84	O-Ring, FKM
75	1	C300-5341-82	O-Ring, EPDM
		C300-5341-84	O-Ring, FKM
76	1	C300-5346-82	O-Ring, EPDM
		C300-5346-84	O-Ring, FKM
79	1	C300-5320-10	Spring assembly



#### 20.4.6 C400 Compact

Number	Quantity	Part Code	Item
70	1	C400-5310-10	Dynamic ring holder
71	1	C400-5340-41	Dynamic face, SiC
72	1	C400-5345-41	Static face, SiC
74	1	C400-5311-82	O-Ring, EPDM
		C400-5311-84	O-Ring, FKM
75	1	C400-5341-82	O-Ring, EPDM
		C400-5341-84	O-Ring, FKM
76	1	C400-5346-82	O-Ring, EPDM
		C400-5346-84	O-Ring, FKM
79	1	C400-5320-10	Spring assembly

#### 20.4.7 C500 Compact

Number	Quantity	Part Code	Item
70	1	C500-5310-10	Dynamic ring holder
71	1	C500-5340-41	Dynamic face, SiC
72	1	C500-5345-41	Static face, SiC
74	1	C500-5311-82	O-Ring, EPDM
		C500-5311-84	O-Ring, FKM
75	1	C500-5341-82	O-Ring, EPDM
		C500-5341-84	O-Ring, FKM
76	1	C500-5346-82	O-Ring, EPDM
		C500-5346-84	O-Ring, FKM
79	1	C500-5320-10	Spring assembly

#### 20.4.8 C600 Compact

Number	Quantity	Part Code	Item
70	1	C600-5310-10	Dynamic ring holder
71	1	C600-5340-41	Dynamic face, SiC
72	1	C600-5345-41	Static face, SiC
74	1	C600-5311-82	O-Ring, EPDM
		C600-5311-84	O-Ring, FKM
75	1	C600-5341-82	O-Ring, EPDM
		C600-5341-84	O-Ring, FKM
76	1	C600-5346-82	O-Ring, EPDM
		C600-5346-84	O-Ring, FKM
79	1	C600-5320-10	Spring assembly

## 20.5 Static flush system



### 20.5.1 C100 Compact

Number	Quantity	Part code	Item
90	1	80-0015-95	Sight glass
91	1	C100-0171-10	Flush pipe
92	1	C100-0173-10	Vent pipe
93	2	80-6009-10	Double nipple
94	2	80-6020-10	Connecting piece
95	1	80-6021-10	Connecting piece

### 20.5.2 C200 Compact

Number	Quantity	Part code	Item
90	1	80-0015-95	Sight glass
91	1	C200-0171-10	Flush pipe
92	1	C200-0173-10	Vent pipe
93	2	80-6009-10	Double nipple
94	2	80-6020-10	Connecting piece
95	1	80-6021-10	Connecting piece

### 20.5.3 C250 Compact

Number	Quantity	Part code	Item
90	1	80-0015-95	Sight glass
91	1	C250-0171-10	Flush pipe
92	1	C250-0173-10	Vent pipe
93	2	80-6009-10	Double nipple
94	2	80-6020-10	Connecting piece
95	1	80-6021-10	Connecting piece

### 20.5.4 C300 Compact

Number	Quantity	Part code	Item
90	1	80-0015-95	Sight glass
91	1	C300-0171-10	Flush pipe
92	1	C300-0173-10	Vent pipe
93	2	80-6009-10	Double nipple
94	2	80-6020-10	Connecting piece
95	1	80-6021-10	Connecting piece

### 20.5.5 C400 Compact

Number	Quantity	Part code	Item
90	1	80-0015-95	Sight glass
91	1	C400-0171-10	Flush pipe
92	1	C400-0173-10	Vent pipe
93	2	80-6009-10	Double nipple
94	2	80-6020-10	Connecting piece
95	1	80-6021-10	Connecting piece

### 20.5.6 C500 Compact

Number	Quantity	Part code	Item
90	1	80-0015-95	Sight glass
91	1	C500-0171-10	Flush pipe
92	1	C500-0173-10	Vent pipe
93	2	80-6009-10	Double nipple
94	2	80-6020-10	Connecting piece
95	1	80-6021-10	Connecting piece

### 20.5.7 C600 Compact

Number	Quantity	Part code	Item
90	1	80-0015-95	Sight glass
91	1	C600-0171-10	Flush pipe
92	1	C600-0173-10	Vent pipe
93	2	80-6009-10	Double nipple
94	2	80-6020-10	Connecting piece
95	1	80-6021-10	Connecting piece

## 20.6 Dynamic flush system

### 20.6.1 C100 Compact

Number	Quantity	Part code	Item
99	2	C100-0504-	Flush connection

### 20.6.2 C200 Compact

Number	Quantity	Part code	Item
99	2	C200-0504-	Flush connection

### 20.6.3 C250 Compact

Number	Quantity	Part code	Item
99	2	C250-0504-	Flush connection

### 20.6.4 C300 Compact

Number	Quantity	Part code	Item
99	2	C300-0504-	Flush connection

### 20.6.5 C400 Compact

Number	Quantity	Part code	Item
99	2	C400-0504-	Flush connection

### 20.6.6 C500 Compact

Number	Quantity	Part code	Item
99	2	C500-0504-	Flush connection

### 20.6.7 C600 Compact

Number	Quantity	Part code	Item
99	2	C600-0504-	Flush connection

## 20.7 Tools

### 20.7.1 Blocking tool

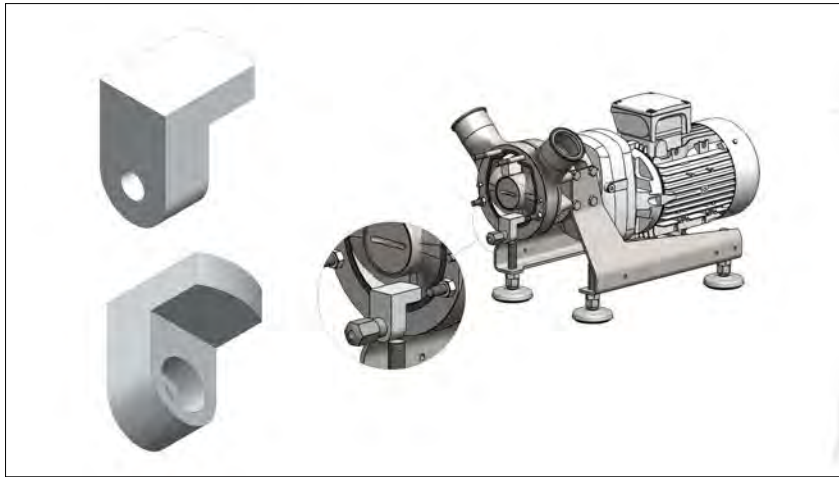

Pump Size	Quantity	Part code	Item
C100 Compact	1	TL-C100-010-31	Blocking tool
C200 Compact	1	TL-C200-010-31	Blocking tool
C250 Compact	1	TL-C250-010-31	Blocking tool
C300 Compact	1	TL-C300-010-31	Blocking tool
C400 Compact	1	TL-C400-010-31	Blocking tool
C500 Compact	1	TL-C500-010-31	Blocking tool
C600 Compact	1	TL-C600-010-31	Blocking tool

### 20.7.2 Socket adapter

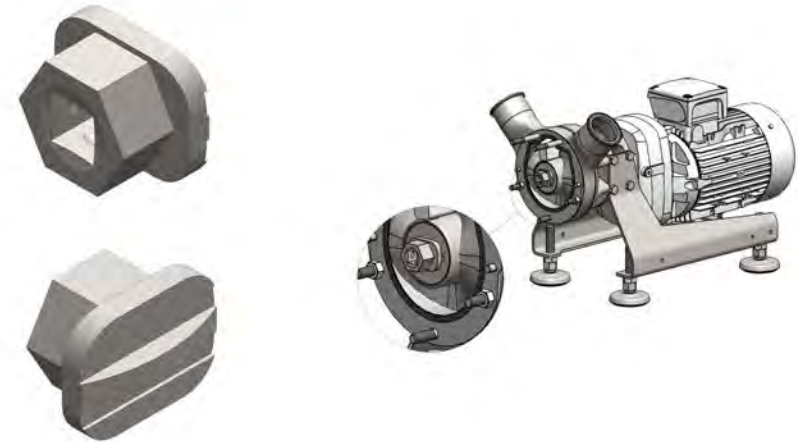

Note: this socket adapter is recommended for EHEDG and / or 3-A applications.

Pump Size	Quantity	Part code	Item
C100 Compact	1	TL-C100-003-10	Socket adapter
C200 Compact	1	TL-C200-003-10	Socket adapter
C250 Compact	1	TL-C250-003-10	Socket adapter
C300 Compact	1	TL-C300-003-10	Socket adapter
C400 Compact	1	TL-C400-003-10	Socket adapter
C500 Compact	1	TL-C500-003-10	Socket adapter
C600 Compact	1	TL-C600-003-10	Socket adapter

#### Required wrench size for hexagonal locking screw

Pump size	Metric	Inch
C100 Compact/C200 Compact	SW14	9/16"
C250 Compact	SW19	3/4"
C300 Compact/C400 Compact	SW34	1 5/16"
C500 Compact/C600 Compact	SW38	1 1/2"

## 21 Trademarks

Certa Compact and MasoSine are trademarks of Watson-Marlow Limited.

## 22 Disclaimers

The information contained in this document is believed to be correct but Watson-Marlow Limited Fluid Technology Group accepts no liability for any errors it contains and reserves the right to alter specifications without notice.

WARNING: This product is not designed for use in and should not be used for, patient-connected applications.

## 23 Publication history

m-certa-compact-en-01 Certa Compact Pump User Manual

Document number	Date	Comment
m-certa-compact-en-01	02 23	First published